



OWNER'S MANUAL

LG CineBeam

DLP Projector

Please read the safety information carefully before using this product.

HF60LS
HF60LSR

www.lg.com

P/NO : SAC37813515 (1901-REV00)

Copyright © 2019 LG Electronics Inc. All Rights Reserved.

LICENSES

Supported licenses may differ by model. For more information about licenses, visit www.lg.com.



The terms HDMI and HDMI High-Definition Multimedia Interface, and the HDMI Logo are trademarks or registered trademarks of HDMI Licensing Administrator, Inc. in the United States and other countries.

Manufactured under license from Dolby Laboratories. Dolby, Dolby Vision, Dolby Audio, Dolby Atmos, and the double-D symbol are trademarks of Dolby Laboratories.

For DTS patents, see <http://patents.dts.com>. Manufactured under license from DTS Licensing Limited. DTS, the Symbol, & DTS and the Symbol together, DTS 2.0 Channel, DTS 2.0+Digital Out, DTS-HD, and DTS Virtual:X are registered trademarks or trademarks of DTS, Inc. in the United States and/or other countries. © DTS, Inc. All Rights Reserved.

NOTE

- Images shown in this manual may differ from your projector.
- Your projector's OSD (On Screen Display) may differ slightly from that shown in this manual.

SAFETY PRECAUTIONS

Please take note of the safety instructions to prevent any potential accident or misuse of the projector.

Child injuries can be prevented by following these simple safety precautions.

The precautions should be followed in the same manner when you store or move your existing projector.

- Safety precautions are given in two forms, i.e., **WARNING** and **CAUTION** as detailed below.

 **WARNING** Failure to follow the instructions may cause serious injury and even death.

 **CAUTION** Failure to follow the instructions may cause personal injury or product damage.

- Read the owner's manual carefully and keep it on hand.



WARNING/CAUTION

RISK OF ELECTRIC SHOCK

DO NOT OPEN



The lightning flash with arrowhead symbol, within an equilateral triangle, is intended to alert the user to the presence of uninsulated dangerous voltage within the product's enclosure that may be of sufficient magnitude to constitute a risk of electric shock to persons.

 The exclamation point within an equilateral triangle is intended to alert the user to the presence of important operating and maintenance (servicing) instructions in the literature accompanying the appliance.

WARNING/CAUTION

- TO REDUCE THE RISK OF FIRE AND ELECTRIC SHOCK, DO NOT EXPOSE THIS PRODUCT TO RAIN OR MOISTURE.

Read these instructions.

Keep these instructions.

Heed all warnings.

Follow all instructions.

Indoor Installation

WARNING

- Do not use the projector outside and do not expose the product to any humidity or water.
 - Since the product is not waterproof, this may result in a fire or electric shock.
- Do not place the projector in direct sunlight or near heat sources such as radiators, fires, stoves, etc.
 - This may result in fire.

- Do not place flammable materials such as aerosols near the projector.
 - This may result in fire.
- Do not allow children to cling to or climb up to the projector.
 - This may cause the projector to fall, causing injury or death.
- Do not install the product in a place with no ventilation (e.g., on a bookshelf or in a closet) or on a carpet or cushion.
 - This may result in fire due to the increase in internal temperature.
- Do not place the product close to sources of steam, oil or oil mist, such as humidifiers and kitchen counters.
 - Failure to do so may result in fire, electric shock, or corrosion.
- Do not install the product onto a wall or ceiling that is close to sources of oil or oil mist.
 - The product may be damaged and fall, resulting in serious injury.
- Do not place the projector where it might be exposed to dust.
 - This may result in fire.
- Do not use the projector in a damp place such as a bathroom where it is likely to get wet.
 - This may result in fire or electric shock.
- Do not allow a tablecloth or curtain to block the air vent.
 - This may result in fire due to the increase in the internal temperature.
- Ensure good ventilation around the projector. The distance between the projector and the wall should be at least 30 cm.
 - This will prevent fire due to the increase in the internal temperature.
- When installing the product on a ceiling, a professional technician should install it using authorized tools. If installed improperly, the product may fall.
 - This may cause personal injury or property damage. For installation of the product, please contact the customer support center.
- If you use a ceiling mounting device, adhesive to prevent loosening of screws, or if you apply oil or lubricant to the product, this may cause the case to crack and the product to fall. This may also cause serious personal injury to the person below the device (if any) and damage to the product as well.

⚠ CAUTION

- When placing the projector on a table or shelf, be careful not to put it near the edge.
 - The projector could fall due to balance problems, which may cause personal injury or damage to the product. Make sure to use the projector cabinet or stand that fits the projector.
- When moving the projector, make sure to switch it off and remove the power plug and cords.
 - The power cord may be damaged, resulting in fire or electric shock.
- Do not place the projector on an unstable or vibrating surface such as a wobbly shelf or a slope.
 - It may fall and cause injury.
- Be careful not to tip the projector over when connecting external devices to the projector.
 - This may cause personal injury or damage to the projector.

Power**⚠ WARNING**

- **DISCONNECTING THE DEVICE FROM THE MAIN POWER**
 - The Power plug is the disconnecting device. In case of an emergency, the Power Plug must remain readily accessible.
- The grounding wire should be connected. (Except for devices which are not grounded.)
 - Ensure that you connect the grounding cable to avoid electric shock. If it is not possible to ground the unit, have a qualified electrician install a separate circuit breaker.
Do not try to ground the projector by connecting it to telephone wires, lightning rods or gas pipes.
- The power plug should be inserted fully into the power outlet.
 - An unstable connection may cause a fire.
- Do not place heavy objects on the power cord.
 - This may result in fire or electric shock.
- Never touch the power plug with wet hands.
 - This may result in electric shock.

- Do not plug too many devices into one multi-power outlet.
 - This may result in fire due to the power outlet overheating.
- Keep the AC adapter, power plug, and the used power outlet clean from dust or foreign materials building up.
 - This may result in fire.
- If there is any smoke or a burning smell from the projector or AC adapter, stop using the product immediately. Disconnect the power cord from the power outlet, and then contact the customer service center.
 - This may result in fire.
- To turn off the main power, remove the power plug, which should be positioned so it is easy to access for operation.

 **CAUTION**

- Always grab the plug to remove the AC adapter or power cord.
 - Otherwise, this may result in a fire or may damage the product.
- Refrain from constantly bending the power cord of the AC adapter.
 - If the power cord is bent excessively for a long period of time, the cord may break inside. This may result in a fire or electric shock.
- Ensure the power cord and plug are not damaged, modified, severely bent, twisted, pulled, sandwiched or hot. Do not use the product if the power outlet is loose.
 - This may result in fire or electric shock.
- Keep the power cord away from heating devices.
 - The wire's sheath may melt, which may result in fire or electric shock.
- Place the projector where people will not trip over or step on the power cord to protect the power cord and plug from any damage.
 - This may result in fire or electric shock.

- Do not turn the projector on or off by plugging in the power plug or unplugging it from the power outlet. (Do not use the power plug as a switch.)
 - This may result in electric shock or damage to the product.
- Do not insert a conductor into the other side of the wall outlet while the power plug is inserted into the wall outlet. In addition, do not touch the power plug immediately after it is disconnected from the wall outlet.
 - This may result in electric shock.
- Only use the official power cord provided by LG Electronics. Do not use other power cords.
 - This may result in fire or electric shock.
- If any water or foreign materials have gone into the AC adapter, power cord, or the interior of the projector, turn off the projector by pressing the power button. Remove all the cables, and then contact the customer service center.
 - This may result in fire or electric shock.
- The surface of the AC adapter is hot. Keep the AC adapter out of the reach of children and avoid touching it during use.
- Never disassemble the power supply devices (AC adapter/power cord, etc.).
 - This may damage the power cord and result in a fire or electric shock.
- Connect the AC adapter and the power cord firmly.
 - Not doing so may result in a product failure or fire.
- Do not place heavy objects or put pressure on the power cord and AC adapter and avoid damage.
 - This may result in a fire or may damage the product.
- Always use the AC adapter provided or any AC adapters approved and certified by LG Electronics.
 - Any other AC adapter connected may result in the screen flickering.

When in Use

WARNING

- Do not place anything containing liquid on top of the projector such as a vase, flower pot, cup, cosmetics, medicine, or ornaments, candles, etc.
 - This may result in fire or electric shock, or cause injury due to falling.
- In the event that there is a heavy impact or the cabinet is damaged, switch it off, unplug it from the power outlet and contact an authorized service center.
 - This may result in electric shock.
- Do not insert pieces of metal such as coins, hairpins or metal debris, nor flammable materials such as paper or matches into the projector.
 - This is to prevent electric shock or fire.
- Make sure that a child does not swallow the batteries when you replace the old batteries in the remote control with new ones. Keep batteries out of reach of children.
 - If a child swallows a battery, consult a doctor immediately.
- Never open any cover on the projector.
 - There is a high risk of electric shock.
- Do not look directly into the lens when the projector is in use.
 - The bright light may damage your eyes.
- When the lamp is on or has just been turned off, avoid touching the air vent or lamp, because these will be very hot.
- If there is a gas leak in the room with the projector, do not touch the projector or power outlet. Open the windows for ventilation.
 - Sparks may cause fire or burns.
- Unplug the power cord from the outlet during a lightning storm.
 - This will prevent shock or damage to the projector.
- Do not use the projector near electronic devices that generate a strong magnetic field.
- Keep the plastic film used for packaging the projector out of the reach of children.
 - If not handled safely, it can cause suffocation.

- Do not keep your hand on the projector for a long time when it is running.
- When you play a game by connecting a game console to a projector, it is recommended that you maintain a distance of more than four times the diagonal length of the screen.
 - Make sure that the connecting cable is long enough. Otherwise, the product may fall causing personal injury or damage to the product.
- Do not place the projector or its remote control with batteries in an extremely high temperature environment.
 - This may result in fire.

 **CAUTION**

- Do not place heavy objects on the projector.
 - It may fall down and cause personal injury.
- Be careful not to allow any impact to the lens during transport.
- Do not touch the lens of the projector.
 - The lens may be damaged.
- Do not use any sharp tools on the projector such as a knife or hammer, because this may damage the casing.
- In the event that no image appears on the screen or no sound is heard, stop using the projector. Switch off the projector, unplug it from the power outlet and contact our service center.
 - This may result in fire or electric shock.
- Do not drop anything onto the projector or allow anything to bang into the projector.
 - This may cause damage to the projector or personal injury.

- It is recommended that you maintain a distance of more than 5 to 7 times the diagonal length of the screen.
 - If you watch the screen at a close distance for a long time, your eyesight may become worse.
- Do not block the light beam emitted from the projector using a book or other object.
 - Lengthy exposure to the projector beam may result in fire. In addition, the lens may be overheated and damaged by the reflected heat. Disable the AV function to stop projection temporarily or turn off the power.
- Do not start the projector with the volume turned up high.
 - High volume may damage hearing.
- Do not use high voltage electrical equipment near the projector, (e.g., a bug zapper). This may result in product malfunction.

Cleaning

WARNING

- Do not spray the projector with water when cleaning. Make sure water does not flow into the projector.
 - This may result in fire or electric shock.
- When there is smoke or a strange smell coming out from the projector or a foreign object falls into the projector, please switch it off and unplug it from the power outlet and contact our service center.
 - Otherwise, this may result in fire or electric shock.

 **CAUTION**

- Contact your seller or our service center once a year to clean the internal parts of the projector.
 - If you do not clean the projector for a long period of time, dust will accumulate, which may result in fire or damage to the projector.
- When cleaning plastic parts such as the projector case, unplug the power first and wipe with a soft cloth. Do not spray with water or wipe with a wet cloth. Never use glass cleaner, automobile or industrial polish, abrasives, wax, benzene, or alcohol as these can damage the projector.
 - This can result in fire, electric shock or cause damage to the product (deformation and corrosion).
- Do not wipe the optical system (lens, mirror) right after the product has been turned off or while the product is being operated. When cleaning each part of the product, remove the power cord and wipe gently with a soft cloth. Do not spray with water or wipe with a wet cloth. Do not use detergents, automobile or industrial polish, abrasive substances, wax, benzene, alcohol, water, etc. on the product's main unit or optical system (lens, mirror) as this may damage the product.
 - This can result in fire, electric shock or cause damage to the product (deformation and corrosion).
- Remove the plug from the outlet before cleaning the product.
 - Otherwise, this may result in electric shock.

Others

WARNING

- When you go out, place the projector out of reach of animals, and remove the power plug from the wall outlet.
 - Using a damaged power cord may result in short circuit or fire.
- Do not use the projector near high-precision electronic devices or those that transmit weak radio signal.
 - This may affect the operation of the product, causing an accident.
- Only a qualified technician can disassemble or modify the projector. For diagnosis, adjustment, or repair, contact your seller or our service center.
 - This may result in fire or electric shock.
- Proper ventilation required, do not block airflow around unit. Doing so can cause injury and internal overheating.
- Do not touch the lens; doing so can result in burns or damage to the lens. The lens and the unit may be HOT during and immediately after use. Use caution when handling the unit, allowing for a proper cool down.
- Only use a grounded electrical outlet. (Except for devices which are not grounded.)
- Do not insert anything into or cover up the exhaust vents.
 - This may result in fire or electric shock.
- Follow all maintenance guidelines for optimal use; service only at an authorized service center.
- Keep the batteries and remote out of reach of children.
 - This will prevent personal injury or damage to the product.

 **CAUTION**

- Do not use or store the projector outdoors for long periods of time.
- Do not mix new batteries with old ones.
 - Burst or leaking batteries may result in damage or injury.
- Be sure to unplug if the projector is not to be used for a long period.
 - Accumulated dust may result in fire or electric shock due to overheating, ignition, or poor insulation.
- Only use the specified type of battery.
 - Burst or leaking batteries may result in damage or injury.
- Make sure you use the same type of battery when replacing.
 - In the case of a battery contact failure, the battery may drain quickly or the remote control may not work properly.
- Dispose of used batteries properly.
 - This may result in explosion or fire. The correct method of disposal may vary depending on your country or region. Dispose of the battery pack as instructed.
- Do not throw or disassemble the battery.
 - This may result in fire or explosion due to damage to the battery.
- Store batteries away from metallic objects, such as keys and paper clips.
 - Excess current may cause a rapid increase in temperature, resulting in fire or burns.
- Do not store the batteries near any heat source, such as a heater.
 - This may result in fire or damage to the product.
- Do not store batteries at temperatures higher than 60 °C or in high humidity.
 - This may result in explosion or fire.
- Make sure that the battery is installed correctly.
 - This prevent explosion or fire.
- Incorrect battery replacement may cause fire.
- Batteries: Store the accessories (battery, etc.) in a safe location out of the reach of children.

Risk Group 2

CAUTION Possibly hazardous optical radiation emitted from this product. Do not stare at operating lamp. May be harmful to the eye.

This label is attached to the bottom of the product and language may differ.

CONTENTS

LICENSES	2	USING THE PROJECTOR	33
SAFETY PRECAUTIONS	3	– Focus and Position of the Screen Image	33
PREPARATION	15	– Watching With the Projector	34
Accessories	15	CONNECTING DEVICES	35
Optional Extras	16	HDMI Connection	36
Parts and Components	17	– Connecting to HD Receiver, DVD, or External Devices	36
– Main Unit	17	– Connecting a PC	37
Using the Joystick Button	19	– Connecting a Laptop	38
– Basic functions	19	Connecting Headphones	39
– Adjusting the menu	20	Connecting a Digital Amp	40
Projector Status Indicators	20	Connecting a smart device (smartphone, tablet, etc.)	41
Installation	21	– Slimport supported devices	41
– Installation Precautions	21	– Apple Lightning Digital AV adapter supported devices	41
– Projection Distance per Screen Size	23	– Apple 30-pin Digital AV adapter supported devices	41
– How to Install the Projector On a Tripod	27	MAINTENANCE	42
– Kensington Security System	28	Cleaning	42
MAGIC REMOTE CONTROL	29	– Cleaning the Lens	42
To Register the Magic Remote Control	31	– Cleaning the Projector Case	42
To Re-register the Magic Remote Control	31	SPECIFICATIONS	43
Using the Magic Remote Control	32	Open Source Software Notice Information	46
		SYMBOLS	47

PREPARATION

The pictures may differ slightly from the actual product.

Accessories

Accessories included with the projector are show below.

Accessories are subject to change without prior notice.

New accessories may be added or old ones removed.

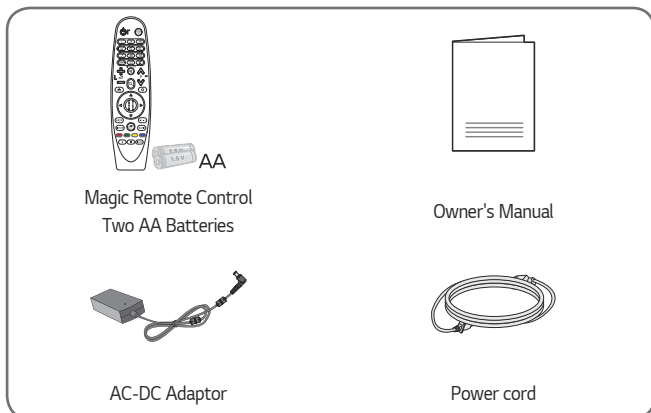

- When connecting an HDMI or USB cable, or connecting a USB flash drive to the HDMI or USB port, use a product that has a width of 18 mm or less and a height of 10 mm or less. If the USB cable or USB flash drive does not fit the USB ports of the projector, use an extension cable that supports USB 2.0.

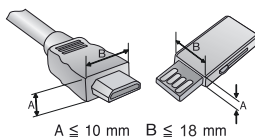

- When connecting two USB devices at the same time, each one should have bezels less than 8.5 mm thick.
- Use a certified cable with the HDMI logo attached.
- If you do not use a certified HDMI cable, the screen may not display or a connection error may occur. (Recommended HDMI cable types)
 - Ultra High-Speed HDMI®/™ Cable (3 m or less)

Optional Extras

To purchase optional accessories, visit an electronics store or online shopping site or contact the retail store where you purchased the product. Optional accessories are subject to change without prior notice.



Projection Screen



Tripod



HDMI Cable



Optical Cable

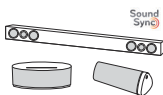

LG Audio Device

Parts and Components

This projector is manufactured using high-precision technology. You may, however, see tiny black dots and/or bright colored dots (red, blue, or green) that continuously appear on the projector screen. This is a normal result of the manufacturing process and does not indicate a malfunction.

Main Unit

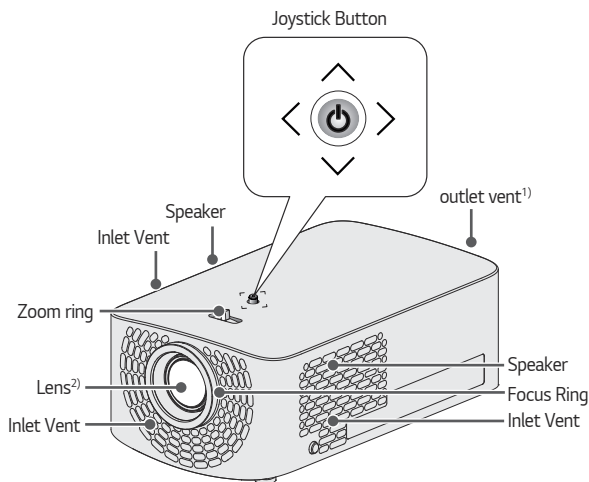

1) Due to the high temperature of vent area, do not get close to the vent area.

2) Do not touch the lens when using the projector. The lens may be damaged. (Keep lens away from sharp objects.)

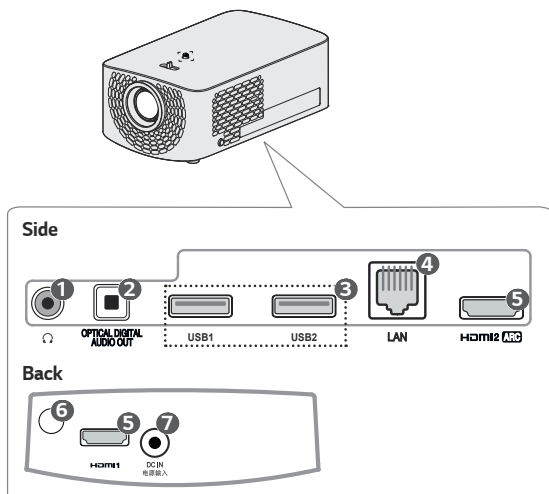





No.	Description
①	🔊 (Headphone Port)
②	OPTICAL DIGITAL AUDIO OUT Port
③	USB port
④	LAN Port
⑤	HDMI Port
⑥	IR Receiver
⑦	DC IN Port

Using the Joystick Button

You can operate the projector by pressing the button or moving the joystick left, right, up, or down.

Basic functions

	Power On	When the projector is turned off, place your finger on the joystick button, press it once, and release it.
	Power Off	Press and hold the joystick button for more than 3 seconds while the projector is on.
	Volume Control	Place your finger over the joystick button and move it left or right, you can adjust the volume level.
	Up/Down/ Left/Right	If you move the joystick up, down, left, or right, you can move the cursor to select the menu items.





! NOTE

- Move the joystick button up, down, left, or right. Be careful not to press the joystick button. If you press the button while moving the joystick, the volume control may not work, and the cursor may not move.

Adjusting the menu

When the projector is turned on, press the joystick button one time.

You can adjust the menu items (⏻, ↶, ✕, ⚙️) moving the joystick button left, right, up, or down. Move to the desired menu item, and then press the joystick button once to select it.

	Turns the power off.
	Changes the input source.
	Clears on-screen displays and returns to projector viewing.
	Displays the Settings menu.

Projector Status Indicators

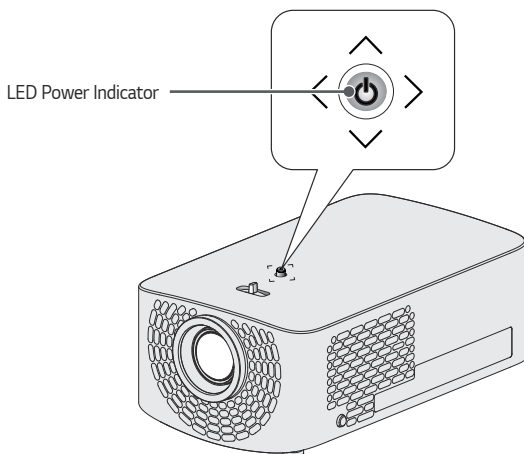

LED Power Indicator	
Red	Power standby state
Off	The projector is operating with the power on.

Installation

Installation Precautions

- Place the projector in a well-ventilated environment.
 - To prevent internal overheating, install the projector in a well-ventilated place. Do not place anything near the projector. That may block its air vents. If the air vents are blocked, the internal temperature of the projector will increase.

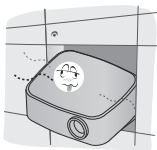

- Do not place the projector on a carpet or rug. If the projector's inlet vent is on the bottom, be careful not to block the vent and always use the projector on a solid, level surface.



- Be sure to prevent foreign objects such as paper debris from entering the projector.

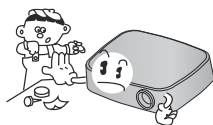

- Leave an adequate open area (30 cm or more) around the projector.

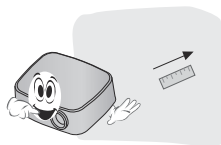

- Do not place the projector in a hot, cool, or humid environment.
- Do not place the projector in a place where it will easily attract dust.
 - This may result in fire.
- Never open any cover on the projector. There is a high risk of electric shock.

- The projector is manufactured using high-precision technology. You may, however, see tiny black dots and/or bright colored dots (red, blue or green) that continuously appear on the projector screen. This is a normal result of the manufacturing process and does not indicate a malfunction.
- The remote control may not work in an environment where a lamp equipped with electronic ballasts or a three-wavelength fluorescent lamp is installed. Replace the lamp with an international standard lamp for the remote control to work normally.
- To install to the ceiling, attach the ceiling-type bracket to the projector with M4 x 8 mm screws.
- Do not overtighten the screws. It may damage the case, causing the projector to fall and cause a serious injury. (Recommended Torque: 5~8 kgf·cm)

Projection Distance per Screen Size

- 1 Place the projector on a sturdy, level surface, together with the PC or audio/video source.
- 2 Place the projector an appropriate distance away from the screen. The distance between the projector and the screen determines the actual size of the image.
- 3 Position the projector so that the lens is at a right angle to the screen. If the projector is not at a right angle, the projected image will look distorted. To correct the distortion, use the Edge Adjustment function.
- 4 Connect the power cord of the projector and the connected device to the wall outlet.

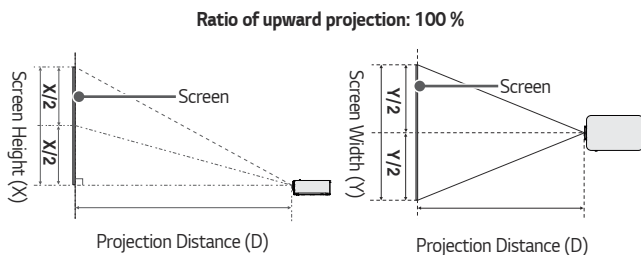

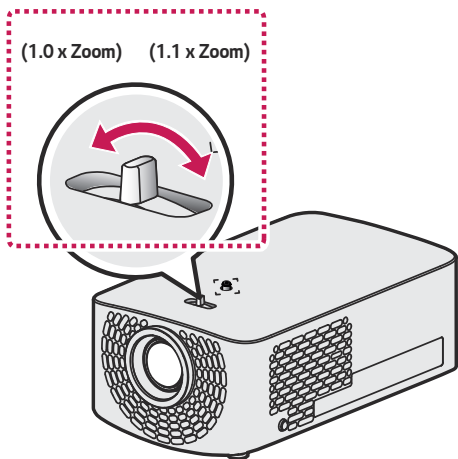

! NOTE

- If the projected image looks distorted or bent, check to see if the screen is installed properly.

16:9 Aspect Ratio (1.1 x Zoom)				
Screen Size		Screen Width (Y)	Screen Height (X)	Projection Distance (D)
inches	mm	mm	mm	mm
30	762	664	374	905
35	889	775	436	1061
40	1016	886	498	1230
45	1143	996	560	1371
50	1270	1107	623	1526
55	1397	1218	685	1682
60	1524	1328	747	1837
65	1651	1439	809	1992
70	1778	1550	872	2147
75	1905	1660	934	2302
80	2032	1771	996	2458
85	2159	1882	1058	2613
90	2286	1992	1121	2768
95	2413	2103	1183	2923
100	2540	2214	1245	3078
105	2667	2324	1308	3234
110	2794	2435	1370	3388
115	2921	2546	1432	3544
120	3048	2657	1494	3698

- The figures in the above table may differ depending on the installation environment.

16:9 Aspect Ratio (1.0 x Zoom)				
Screen Size		Screen Width (Y)	Screen Height (X)	Projection Distance (D)
inches	mm	mm	mm	mm
27.2	693	604	340	905
31.8	808	704	396	1061
36.3	924	805	453	1230
40.9	1039	906	509	1371
45.4	1155	1006	566	1526
50	1270	1107	623	1682
54.5	1385	1208	679	1837
59.0	1501	1308	736	1992
63.6	1616	1409	792	2147
68.1	1732	1509	849	2302
72.7	1847	1610	906	2458
77.2	1963	1711	962	2613
81.8	2078	1811	1019	2768
86.3	2194	1912	1075	2923
90.9	2309	2013	1132	3078
95.4	2425	2113	1189	3234
100	2540	2214	1245	3388
104.5	2655	2314	1302	3544
109.0	2771	2415	1358	3698

- The figures in the above table may differ depending on the installation environment.

How to Install the Projector On a Tripod

- You can install the projector using a camera tripod.
- As shown below, you can mount the projector instead of a camera on the tripod.
- When stabilizing the tripod, we recommend using a locking bolt of standard size 4.5 mm or less. The maximum size allowed for the locking bolt is 5.5 mm. (If it is longer than the maximum allowed size, it may damage the projector.)

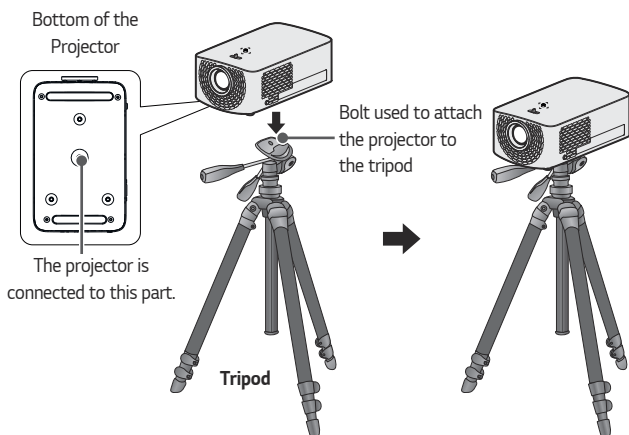

CAUTION

- If you are using a tripod, be careful not to apply external force to the tripod. Doing so may damage the projector.
- Do not place the tripod on an unstable surface.
- Be sure to use a tripod with a maximum load capacity of 3 kg or more.
- To use the projector safely, position the tripod legs so that they are as wide and stable as possible and be sure to securely attach the projector to the tripod.

Kensington Security System

- This projector has a Kensington Security Standard connector as an anti-theft mechanism. Connect a Kensington Security System cable as shown below.
- For more information on installation and use of the Kensington Security System, refer to the user's guide provided with the Kensington Security System.
- The Kensington Security System is an optional accessory.
- What is Kensington?
Kensington is a company that provides safety systems for laptops and other electronic devices. Website: <http://www.kensington.com>

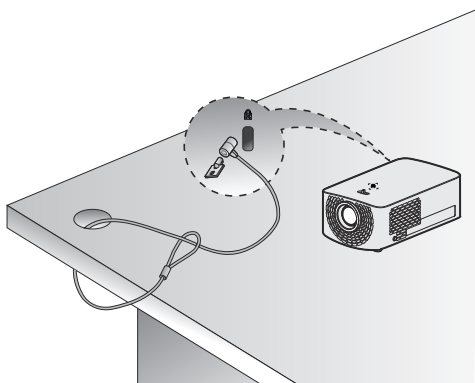

MAGIC REMOTE CONTROL

If the battery low message appears while using the Projector, replace the batteries.

As shown in the figure, press the top of the battery cover and slide it down the cover. Insert two new and identical batteries (1.5 V, AA type) with + and - poles pointing in the correct direction in the remote control.

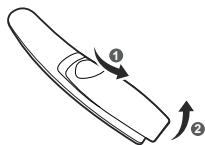

! NOTE

- Do not mix new batteries with old ones.

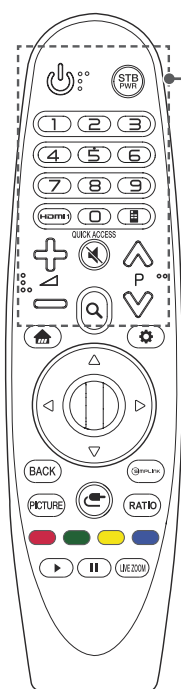

(POWER)

Turns the Projector on or off.

(STB POWER)

You can turn your set-top box on or off by adding the set-top box to the universal remote control for your Projector.

Number buttons

Enters numbers.

HDMI 1

Change the input source to [HDMI1].

QUICK ACCESS *

You can access apps using the number buttons corresponding to the features.

(Screen Remote)

Displays the Screen Remote.

- Accesses the Universal Control Menu in some regions.

Adjusts the volume level.

(MUTE)

Mutes all sounds.

(MUTE) *

Accesses the [Accessibility] menu.

Moves to the previous/next page.

(SEARCH)

Search for content such as movies and other videos, or perform a web search by entering your search terms in the search box.

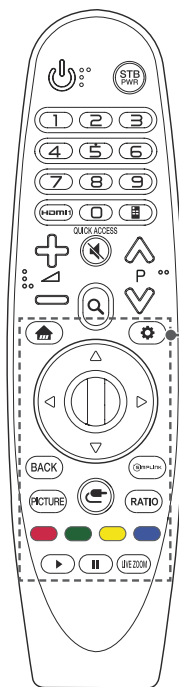

Accesses the Home menu.



Displays the list used previously.



(Q. Settings)

Accesses the Quick Settings.



(Q. Settings) *

Displays the [All Settings] menu.



(Up/Down/Left/Right)

Press the up, down, left or right button to scroll the menu.

If you press \triangle ∇ \triangleleft \triangleright buttons while the pointer is in use, the pointer will disappear from the screen and Magic Remote will operate like a general remote control. To display the pointer on the screen again, shake Magic Remote to the left and right.



Wheel (OK)

Press the center of the **Wheel (OK)** button to select a menu. You can change pages by using the Wheel button.

BACK

Returns to the previous screen.

BACK *

Clears on-screen displays and returns to last input viewing.

PICTURE

Changes the picture mode.



SIMPLINK

Allows you to use the SIMPLINK function.



(INPUT)

Changes the input source.



(INPUT) *

Displays all the lists of external inputs.

RATIO

Changes the aspect ratio of the screen per pressing of the button.

Coloured buttons

These access special functions in some menus.

Control buttons (\blacktriangleright , \parallel)

You have access to premium content, video content and devices that support SIMPLINK.

LIVE ZOOM

By zooming in on the selected area, you can view it in full screen.



* : To use the button, press and hold for more than 3 seconds.

To Register the Magic Remote Control



To use the Magic Remote control, register it with your projector first.

- 1 Put batteries into the Magic Remote and turn the Projector on.
- 2 Point the Magic Remote at your projector and press the  **Wheel (OK)** on the remote control.
 - If the projector fails to register the Magic Remote, try again after turning the projector off and back on.

To Re-register the Magic Remote Control

- 1 Press the  and **BACK** buttons at the same time, for five seconds, to unpair the Magic Remote with your projector.
- 2 Press the  **Wheel (OK)** button towards the projector to re-register the magic remote control.

Using the Magic Remote Control

- Shake the Magic Remote slightly to the right and left or press ,  (INPUT) buttons to make the pointer appear on the screen.
- If the pointer has not been used for a certain period of time or Magic Remote is placed on a flat surface, then the pointer will disappear.
- If the pointer is not responding smoothly, you can reset the pointer by moving it to the edge of the screen.
- The Magic Remote depletes batteries faster than a normal remote due to the additional features.

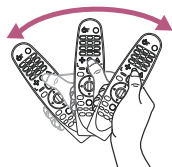
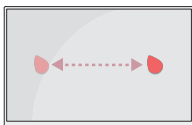

CAUTION

- Use the remote control within the specified range (within 10 m). You may experience communication failures when using the device outside the coverage area or if there are obstacles within the coverage area.
- You may experience communication failures depending on the accessories. Devices such as a microwave oven and wireless LAN operate in the same frequency band (2.4 GHz) as the Magic Remote. This may cause communication failures.
- The Magic Remote may not work properly if a wireless router (AP) is within 1 m of the projector. Your wireless router should be more than 1 m away from the projector.
- Do not disassemble or heat the batteries.
- Do not drop the battery. Avoid extreme shocks to the battery.
- Inserting a battery in the wrong way may result in explosion.

USING THE PROJECTOR

Focus and Position of the Screen Image

When an image appears on the screen, check if it is in focus and fits the screen properly.

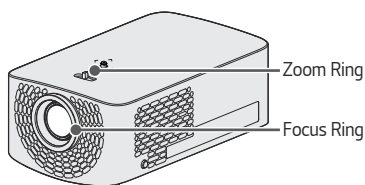



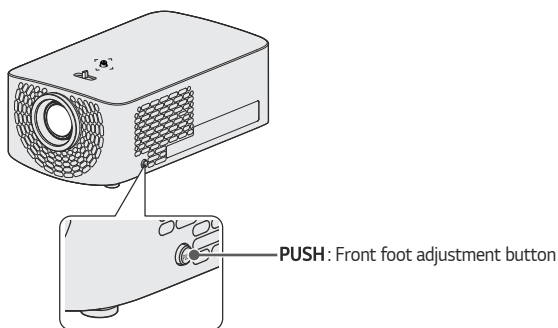

- To adjust the focus of the image, rotate the focus ring.
- To adjust the size of the image, rotate the zoom ring. To move the screen image upward/downward, adjust the height of the foot at the bottom of the projector.



- While pressing the **PUSH** button, adjust the projector upward/downward until the screen image is in the desired position.
- When you release the **PUSH** button, the front foot becomes fixed at the current position.

Watching With the Projector

- 1 When in standby mode, press the  (**POWER**) button to turn the projector on.
- 2 Select the  (**INPUT**) → [All Inputs] and select the input signal you want.
- 3 Control the projector using the following buttons while watching projector.

Button	Description
 P	Moves to the previous/next page.
	Adjusts the volume level.
 (MUTE)	Mutes the sound from the projector.

- 4 To turn the projector off, press the  (**POWER**) button.

CONNECTING DEVICES

You can connect various external devices to the projector.

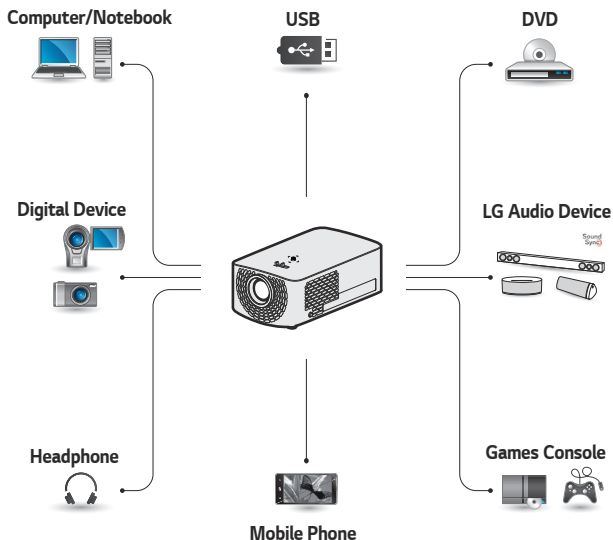

HDMI - Page 36, 37, 38

Headphone - Page 39

Digital Amp - Page 40

Smart device - Page 41

HDMI Connection

Connect an HD receiver, DVD, or external devices to the projector and select an appropriate input mode.

You can connect with any HDMI input port.

-  (INPUT) → [All Inputs] → [HDMI1]/[HDMI2]

Connecting to HD Receiver, DVD, or External Devices

With an HDMI cable, you can enjoy high quality picture and sound.

Using a HDMI cable, connect the **HDMI** port of the projector to the HDMI output port of the device to connect. Both video and audio are output at the same time.

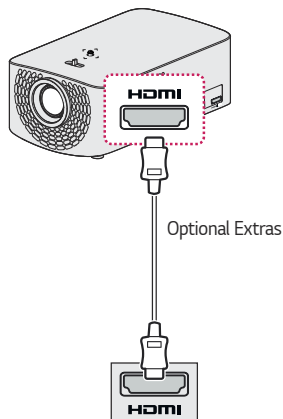

NOTE

ARC (Audio Return Channel)

- External audio devices that support SIMPLINK and ARC must be connected using **HDMI2 ARC** port.
- When connected with a high-speed HDMI® cable, external audio devices that support ARC output or SPDIF work with the SIMPLINK function without the need for an additional optical audio cable.

Connecting a PC

The projector supports Plug and Play. Your PC will automatically detect the projector and requires no driver installation.

Using an HDMI cable, connect the **HDMI** port of the projector to the HDMI output port of your PC. Both video and audio are output at the same time.

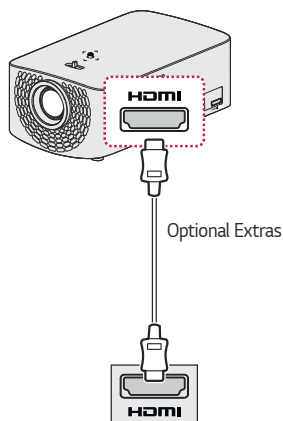

Connecting a Laptop

You can connect the projector to a laptop to use various functions.

Using an HDMI cable, connect the **HDMI** port of the projector to the HDMI output port of your laptop. Both video and audio are output at the same time.

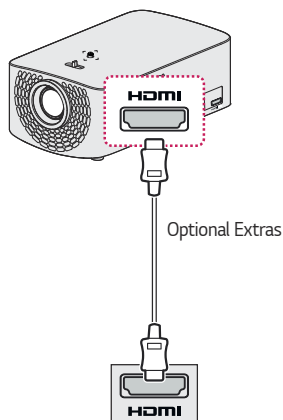

Examples of switching output settings when connecting a laptop

The table below shows examples of switching the output. For more information, refer to the **External Output, Connecting to an External Monitor**, or similar sections of the owner's manual of your computer.

Brand	Switching Output
Lenovo	$\text{Fn} + \text{F7}$
HP	$\text{Fn} + \text{F4}$
Dell	$\text{Fn} + \text{F8}$
Acer	$\text{Fn} + \text{F5}$
ASUS	$\text{Fn} + \text{F8}$
LG	$\text{Fn} + \text{F7}$
Samsung	$\text{Fn} + \text{F4}$
Apple	Adjust the control panel to enable mirroring after start-up.

Connecting Headphones

You can listen to the audio through a headphone.

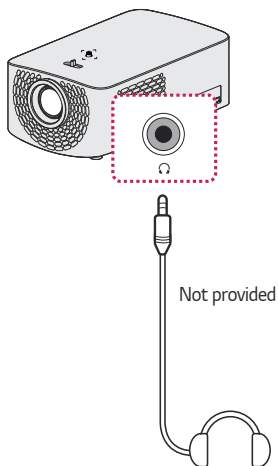

Connecting a Digital Amp

Using an optical cable, connect the digital audio input port of a digital amp to the **OPTICAL DIGITAL AUDIO OUT** port of the projector. The output of an amp with a digital converter must be set to the desired audio format. When using a HDMI cable to connect a home theater or when connecting an optical output to an external audio device, set [Sound Out] to [HDMI ARC] or [Optical]. If a projector, home theater, or the speaker of an external audio device is operating at the same time, there will be an echo.

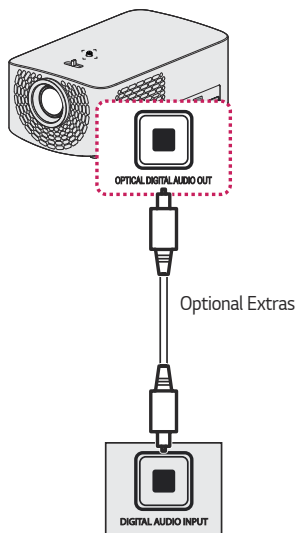

! NOTE

- Refer to the user manual of the audio device to connect.
- When connecting this product to other devices, make sure to turn off and unplug all the devices.
- The audio output of this product has wide-ranging audio bandwidth, so the receiver volume must be adjusted properly. Speakers can be damaged by unexpected high frequencies.
- Connecting the **OPTICAL DIGITAL AUDIO OUT** port of the projector to the digital audio input port of a digital amp and the audio input port of the projector to the analog audio output port of the digital amp can cause sound oscillation due to the closed loop. Remove one of the two connections to prevent this. (This also applies to home theater devices.)

Connecting a smart device (smartphone, tablet, etc.)

-  (INPUT) → [All Inputs] → [HDMI1]/[HDMI2]
- The picture may look different from the actual product.

Connect a smart device to the projector using a cable¹⁾ and set the external input of the projector to HDMI. The smart device screen will then be displayed through the projector. You can connect with any HDMI input port.

For model-specific instructions regarding use of the wired connection, please check with the smart device manufacturer.

Supported smart devices may change depending on the circumstances of each manufacturer.

1) Examples of how to connect a cable to different smart devices (cable purchased separately).

Slimport supported devices

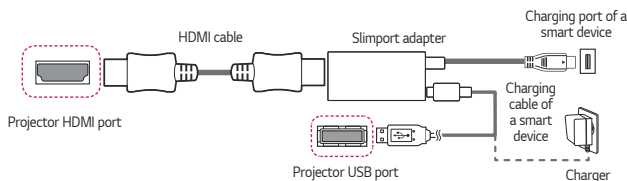

Apple Lightning Digital AV adapter supported devices

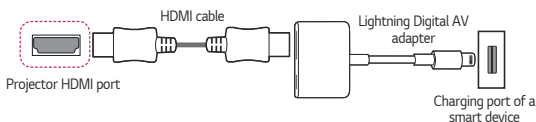

Apple 30-pin Digital AV adapter supported devices

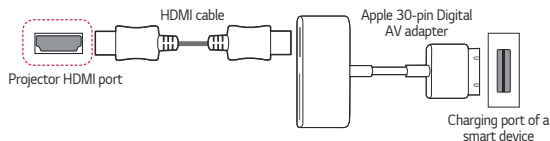

MAINTENANCE

Clean your Projector to keep it in optimal condition.

Cleaning

Cleaning the Lens

- If there is any dust or staining on the lens surface, you must clean the lens.
- To remove dust or stains on the lens, use a compressed air duster, cotton swab, or soft cloth to gently wipe the lens.
- Do not wipe the lens while the product is in use or immediately after it has been turned off.
- When cleaning the lens, do not use a cleanser, automobile or industrial shiner, abrasive, wax, benzene, alcohol, water, etc., as this may damage the product.

Cleaning the Projector Case

- To clean the projector case, first unplug the power cord.
- To remove dust or stains, use only a dry, lint-free, nonabrasive cloth to polish the lens.
- Do not use alcohol, benzene, thinners, or other chemicals, which may damage the case.

SPECIFICATIONS

MODEL	HF60LS (HF60LS-EU) HF60LSR (HF60LSR-EU)	
Resolution (Pixel)	1920 (Horizontal) × 1080 (Vertical)	
Aspect ratio	16:9 (Horizontal:Vertical)	
Projection distance – Screen size	905 mm to 3698 mm – 762 mm to 3048 mm (30 inches to 120 inches)	
Ratio of upward projection	100 %	
Power consumption	100 W	
	Networked standby: 1.3 W (If all network ports are activated.)	
AC-DC Adaptor	Manufacturer: Honor Model: ADS-110CL-19-3 190110G	
	19 V  5.79 A (Adaptor Input 100-240 V @ 50/60 Hz)	
Audio Output	3 W + 3 W	
Height	84 mm (without foot), 87 mm (with foot)	
Width	132 mm	
Depth	213 mm (without lens), 220 mm (with lens)	
Weight	1.42 kg	
USB Device	5 V, 0.5 A (Max.)	
Environment Condition	Temperature	
	Operation	0 °C to 40 °C
	Storage	-20 °C to 60 °C
	Relative Humidity	
	Operation	0 % to 80 %
	Storage	0 % to 85 %

- Use only power supplies listed in the user instructions.
- Contents in this manual may be changed without prior notice due to upgrade of product functions.
- The network port can be activated/deactivated from the menu of the projector by selecting the [Mobile Projector On] feature.

HDMI (DTV) Supported Mode

Resolution	Horizontal Frequency (kHz)	Vertical Frequency (Hz)
640 x 480p	31.46	59.94
	31.50	60.00
720 x 480p	31.47	59.94
	31.50	60.00
720 x 576p	31.25	50.00
1280 x 720p	44.96	59.94
	45.00	60.00
	37.5	50.00
1920 x 1080i	28.12	50.00
	33.72	59.94
	33.75	60.00
1920 x 1080p	26.97	23.97
	27.00	24.00
	33.71	29.97
	33.75	30.00
	56.25	50.00
	67.43	59.94
	67.50	60.00

HDMI (PC) Supported mode

Resolution	Horizontal Frequency (kHz)	Vertical Frequency (Hz)
640 x 350	31.46	70.09
720 x 400	31.46	70.08
640 x 480	31.46	59.94
800 x 600	37.87	60.31
1024 x 768	48.36	60.00
1152 x 864	54.34	60.05
1280 x 1024	63.98	60.02
1360 x 768	47.71	60.01
1920 x 1080	67.5	60.00

- If an invalid signal is input into the projector, it will not be displayed properly on the screen or a message such as [No Signal] or [Invalid Format] will be displayed.
- The projector supports the DDC1/2B type as the Plug and Play function (Auto-recognition of PC monitor).
- 1920 x 1080 is recommended as the best picture quality in the PC mode.

Open Source Software Notice Information







To obtain the source code under GPL, LGPL, MPL, and other open source licenses, that is contained in this product, please visit <http://opensource.lge.com>.

In addition to the source code, all referred license terms, warranty disclaimers and copyright notices are available for download.

LG Electronics will also provide open source code to you on CD-ROM for a charge covering the cost of performing such distribution (such as the cost of media, shipping, and handling) upon email request to opensource@lge.com.

This offer is valid for a period of three years after our last shipment of this product. This offer is valid to anyone in receipt of this information.

SYMBOLS

	Refers to alternating current (AC).
	Refers to direct current (DC).
	Refers to class II equipment.
	Refers to stand-by.
	Refers to "ON" (power).
	Refers to dangerous voltage.





ABOUT LG PROJECTOR

Image shown may differ from your projector.

Your projector's OSD (On Screen Display) may differ slightly from that shown in this manual.

[] : the buttons and the text to be displayed on the projector screen.

CONTENTS

ABOUT LG PROJECTOR 4

Home Tutorial	4
– Using the Home feature of the LG Projector	4
Network Setting	8
– Network Setting	8

HOW TO OPERATE PROJECTOR 10

Using the Screen Remote	10
Setting Universal Control	12
Launching Apps through [QUICK ACCESS]	13
– Using apps quickly and easily with [QUICK ACCESS]	13
SIMPLINK (HDMI-CEC)	15
– Using SIMPLINK	15
Using the LG TV Plus App	17
– Connecting Your Smart Device to a Projector Using the LG TV Plus App	17
– Controlling Your Projector with the LG TV Plus App	18
Mobile Connection	19
– Using Mobile Connection	19
Using a Keyboard and Mouse	20
– Using a USB Wired/Wireless Mouse	20
– Using a USB Wired/Wireless Keyboard	20
Using a Gamepad	21

HOW TO USE VARIETY OF CONTENTS 22

LG Content Store	22
Creating Wish List	23
– Using [My Content]	23
Account Creating	24
– Creating LG Account	24
Account Management	25
– Managing your LG Account	25
Search Content	26
– [Search]	26
– Searching for Content	26
Use App & Contents	27
– Installing Apps	27
Watching VOD Content	28

PLAY OTHER DEVICE FILES 29

[Photo & Video]	29
– Viewing Photos and Videos	29
– Photo Player	30
– Video Player	32
– Supported Video Files	34
– Cautions for Video Playback	36
[Music]	37
– Playing Music	37
– Using the Music Player	38
[File Viewer]	41
– Viewing Files	41
– Browsing File Viewer	42

Connecting USB	44	TOUR LIST OF SETTINGS	60
– Tips for Using a USB storage device	45	Quick Settings	60
		– To use Setting function quickly	60
Share Smart Phone	46	[Picture] Settings	61
– Content Share with Smartphone	46	[Sound] Settings	68
		[Network]	75
Share Smartphone Screen	48	[General]	77
– To see the Mobile Device's screen on the projector	48	[Safety] Settings	85
		[Accessibility]	86
Share Computer Content	49	TO UPDATE SOFTWARE	87
– What Is Content Share?	49	TROUBLESHOOTING	88
		Abnormal Operation	88
Share Computer Screen	52	Screen Problems	89
– To see the PC screen on the projector	52	Sound Problems	90
		PC Connection Problems	91
BENEFITS OF SMART PROJECTOR	53	[Photo & Video] Movie Playback Problems	92
Zooming in the Projector Display	53	Network Connection Problems	94
– Moving the Position of an Enlarged Screen	54	LG Account Problems	96
		Contents Problems	97
Enjoying Internet	55	Internet Browser Problems	97
– Using the [Web Browser]	55		
Playing Sound from a Smart Device through the Projector's Speakers	58		
Notifications	59		
– Using [Notifications]	59		





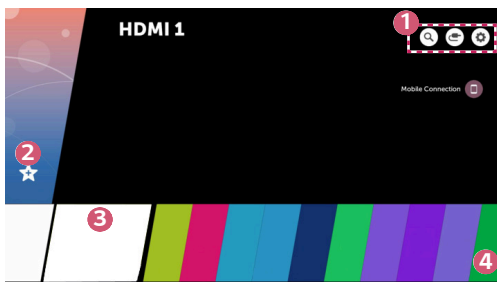

ABOUT LG PROJECTOR

Home Tutorial

Using the Home feature of the LG Projector

You can open the Home screen by pressing the  button on your remote control. You can combine frequently used apps on a single screen and use whichever you want at any time.



Description	
1	 Launch [SEARCH].
	 You can switch to another input or change your settings.
	 You can easily change the settings of your projector. Select  for advanced setup.
2	Add content you like to use, easily and quickly. (This feature is not supported in some countries. When you select the feature, you will be directed to the LG Content Store.)
3	This is a list of recently used apps. To access the list of recently used apps, select this item and then press and hold the  Wheel (OK) or  OK button. You can view all the apps you used recently in the list.
4	You can run, move, and delete all the apps installed on your projector.

Using Recent List

To access the list of recently used apps, press and hold the  button on your remote control, or press and hold a recently used item on the Home screen. You can run or exit all the apps you've used recently.



	Description
1	Exit the app.

Managing Apps

You can view a list of all apps installed on your projector, change their positions, or delete them.

- Some apps cannot be edited.

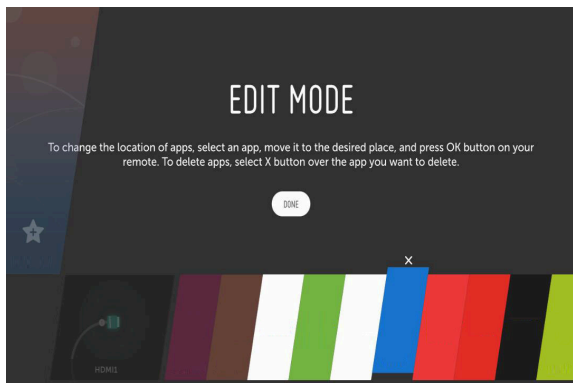

- 1 Select the app you want to edit, and press and hold the **Wheel (OK)** or **OK** button on the Remote Control. This will activate the app edit mode.
- 2 To move the app to your desired position, go to the position and press the **Wheel (OK)** or **OK** button. To delete an app, select the **X** above the app.
 - You can move and delete as many apps as you wish before exiting the edit mode.
 - You can also move apps with the **◀ ▶** buttons on your remote control.
- 3 When you have completed the edit, click **[DONE]** to exit the app edit mode.

Stopping the current function





- 1 Press the  button on the remote control.
- 2 Select the application name at the top left corner of the screen by the Remote Control to display the Close icon.
- 3 Select the Close icon displayed next to the application name to quit the function in use.

Network Setting



Network Setting

If you configure settings for the network, you can use various services such as online contents and applications.

Setting a Wired Network

- 1 Connect the LAN port of the projector and the router using a LAN cable. The router should be connected to the Internet beforehand.
- 2 Press the  (**Q. Settings**) button on the remote control and select  → [Network] → [Wired Connection (Ethernet)]. This will start the wired network connection.
 - If the router supports DHCP, the projector is automatically connected to the network when you connect the projector to the network with a LAN cable.

Setting a Wireless Network

- 1 Turn on the power of the router connected to the Internet.
- 2 Press the  (**Q. Settings**) button on the remote control and select  → [Network] → [Wi-Fi Connection]. This will start the Wireless network connection.
- 3 When the network search is complete, the list of networks available for connection is shown.
- 4 Select a network to connect. If your Wireless Router is password protected, enter the password configured for the router.

Network Setting Warnings

- Use standard LAN cable (connect to Cat7 or higher with RJ45 connector, 10 Base-T, or 100 Base TX LAN port).
- Resetting the modem may fix some network connection problems. Turn the power OFF, disconnect and reconnect it, and then turn the power on to solve the problem.
- LG Electronics is not responsible for any network connection problems or any faults, malfunctions, or errors caused by network connection.
- The network connection may not work properly because of network settings or the Internet service provider.
- DSL service must use a DSL modem; and cable service must use a cable modem. Since only a limited number of network connections may be available, projector network setting may not be used depending on the contract with Internet service provider. (If the contract does not allow more than one device per line, only the already-connected PC may be used.)
- A wireless network can experience interference from other devices that use the 2.4 GHz frequency (wireless phone, Bluetooth device, or microwave oven). Although interference can also happen when using the 5 GHz frequency, it is less likely to occur.
- The wireless environment can make wireless network service run slowly.
- Failure to turn off all local home networks may cause excessive traffic on some devices.
- The access point device must support wireless connections and wireless connection feature must be enabled on the device to have AP (access point) connection. Contact the service provider for availability of wireless connections on the access point.
- Check SSID and security settings of the AP. Refer to the appropriate documentation for SSID and security settings of the AP.
- Invalid settings of network devices (wired/wireless line sharer, hub) can cause the projector to operate slowly or not operate properly. Install the devices correctly according to the appropriate manual and network.
- The connection method may differ depending on the AP manufacturer.

HOW TO OPERATE PROJECTOR

Using the Screen Remote

You can control external devices connected to your projector by using the Screen Remote displayed on your projector screen.

- This feature is available on certain models only.

- 1 Press the  button on the Magic Remote.
- 2 Using the Magic Remote, select your desired button on the Screen Remote displayed on your projector screen.

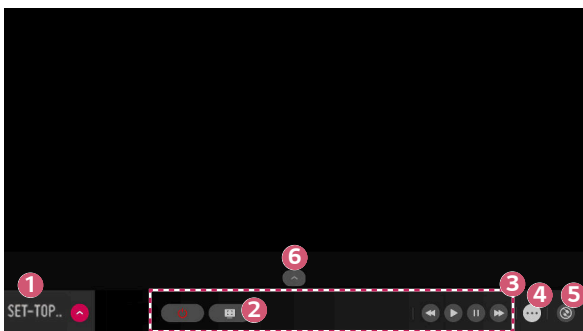





	Description
1	<p>Configure [Set Up Universal Control] for external devices connected to your projector.</p> <p>When you select a device, the Screen Remote turns into the remote control for the device.</p> <p>If a sound bar is connected, the Screen Remote can be used as a remote control for the sound bar.</p>
2	<p>You can capture your projector screen.</p> <ul style="list-style-type: none"> This feature is available on certain models only. You can view/delete screen-captured images in the [Photo & Video] app.
3	The buttons suitable for the selected device appear.
4	You will see more remote control buttons.
5	You can start the [Device Connector] app. You can set the universal remote control.
6	You can change the position of the screen remote control.

- This feature can only be used with the Magic Remote.
- You can purchase the Magic Remote separately if it is not provided.
- The types of buttons appearing on the Screen Remote vary, depending on the region and the type of connected device.
- Some features and services may not be provided depending on models or regions.

Setting Universal Control

You can control devices such as Set-Top Box, Blu-ray Player, or Home Theater using by Magic Remote.

- This feature is available on certain models only.
- 1** Check that the device you want to set is connected to your projector.
- 2** Press the  button on the remote control and select  at the top right. (Press the  button on the remote control.)
- 3** Select [All Inputs] and go to [INPUTS].
- 4** Select the input mode that the device is connected to in [INPUTS].
- 5** If you press [Set Up Universal Control], you can set up the Universal Control. Follow the instructions on the screen to finish the setup.
- If you want to change or cancel Universal Control Settings, go to  → [All Inputs] and select [Edit Universal Control].
- You can also set the Universal Control in  → [Device Connector].
- You can use this only with the Magic Remote. (The provided remote control differ depending upon model.)
- You can purchase the Magic Remote separately if it is not provided.
- This feature is available in certain countries only.
- When changing the settings, check that the device to be changed is turned on.
- You can set one device per type.
- If you connect to a network before setting the Universal Control, the latest update for the supported manufacturer list becomes available.
- Some buttons may not work depending upon the model of the external device.
- Place the device near the projector for seamless operation.
- If there is an obstacle in front of the device, it may not be able to receive the signal properly. If the device is in a drawer, open the drawer.

Launching Apps through [QUICK ACCESS]

Using apps quickly and easily with [QUICK ACCESS]

- Press and hold a number button on the remote control to open an app or to activate an external input registered to the button.

Setting the [QUICK ACCESS]

- 1** Launch the app or input you wish to assign.
- 2** Press and hold the number button (1-9) you want to register.
- 3** When the registration pop-up window appears, select [Yes].
 - If you press and hold a number button that has already been registered, the registered function will be performed.
 - To see the items that can be registered, select a number that has not been registered in the [QUICK ACCESS] edit mode.
 - If you are in a mode where [QUICK ACCESS] cannot run, no action will be performed.
 - If you delete a registered app, [QUICK ACCESS] will be deregistered as well.

Checking and editing QUICK ACCESS

Press and hold the number **0** button on the remote control.

The [QUICK ACCESS] edit screen appears.

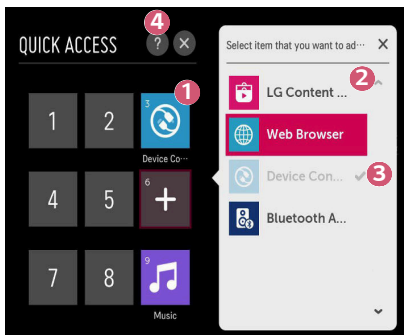





	Description
1	Selecting a number that has already been registered allows deregistering it.
2	When you select a number that has not been registered, items that can be registered will be shown.
3	An item that has been registered to a different number is indicated with a check mark.
4	You can view a brief instruction for this function.

SIMPLINK (HDMI-CEC)

Using SIMPLINK

You can conveniently control and use various multimedia devices connected through HDMI with the projector's remote control.

- 1 Connect the SIMPLINK HDMI Output port to the projector's HDMI IN port with an HDMI cable.
- 2 Press the  (**Q. Settings**) button on the remote control and select  → [General] → [SIMPLINK (HDMI-CEC)].
- 3 Set [SIMPLINK (HDMI-CEC)] to [On].
- 4 Configure the [Auto Power Sync] settings to [On] or [Off]. (If [Auto Power Sync] is set to [On], turning on a SIMPLINK-linked device will turn the projector on. When you turn off the projector, the device will also be turned off.)
- 5 Turn on the connected device. When the projector automatically connects to the device, the input will switch. If the device is not automatically connected to the projector, click the  (**INPUT**) button.
 - This feature works only with devices with the  logo. Check for the SIMPLINK logo on the external device. There may be a problem using the device if the device does not meet the required specifications.
 - A high-speed HDMI[®] cable with CEC (Consumer Electronics Control) function is required to use SIMPLINK. Pin 13 of the high-speed HDMI[®] cable is used for data transfer between devices.
 - If you want to output sound to the external audio equipment connected through the HDMI cable, set [SIMPLINK (HDMI-CEC)] to [On].

Supported SIMPLINK Functions

- **Instant Play**

When you start a multimedia device, you can immediately watch content from the device on the projector without having to control anything.

- **Controlling devices with the projector remote control**

Enables the user to control multimedia devices with the projector remote control to watch content.

- The pointer function of the Magic Remote can be limited.

- **Main Power Off**

If [Auto Power Sync] is set to [On] in the [SIMPLINK (HDMI-CEC)] settings and the projector is turned off, the devices connected to your projector via SIMPLINK will also be turned off. Likewise, your projector will be turned off if you turn off a device connected to your projector via SIMPLINK.

- This feature is only available in certain devices.

- **Main Power On**



If [Auto Power Sync] is set to [On] in the [SIMPLINK (HDMI-CEC)] settings, turning on a SIMPLINK-linked device will turn the projector on.

- If [SIMPLINK (HDMI-CEC)] is set to [Off], [Auto Power Sync] cannot be set to [On].

Using the LG TV Plus App

You can control the functions of your projector by using the app installed on your smart device.

Connecting Your Smart Device to a Projector Using the LG TV Plus App

- 1 Download LG TV Plus app from the app store of your smart device.
- 2 Press the  (**Q. Settings**) button on the remote control and select  → [Network].
- 3 Set [LG Connect Apps] to [On].
- 4 Connect the projector and your smart device on the same Wi-Fi network.
- 5 Run the LG TV Plus app installed on your smart device.
- 6 The app will automatically scan for projectors that can be connected to your smart device.
- 7 Select the projector you want from the list of search results. A PIN code appears on the projector screen.
- 8 Enter the PIN code in the LG TV Plus app to pair your smart device with the projector.

Controlling Your Projector with the LG TV Plus App

You can tap the buttons on your smart device's screen to control the projector.

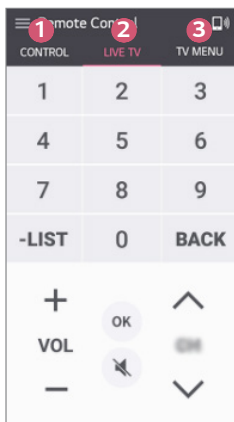

	Description
1	You can use the same functions as the Magic Remote's pointer and arrow keys.
2	You can adjust the volume or make other adjustments without using the remote control.
3	You can open an app installed on your Projector or configure settings for functions such as switching input.

- Some controls may be limited in external input mode.
- The app's screen and functionality are subject to change without prior notice.
- Available features may differ depending on your country and OS.

Mobile Connection

Using Mobile Connection

Mobile Connection lets you share and enjoy the content stored on people's smart devices through your projector.

- It is recommended that your Android smart devices run Lollipop or later versions of Android.

Connecting a Smart Device with Mobile Connection

Set up a connection following the guide below:

- 1** Install the LG TV Plus app on the smart device.
 - 2** Connect both your projector and the smart device to the same network.
 - 3** Run the LG TV Plus app and set up a connection to your projector following the instructions shown on the screen.
 - 4** Press the  button, and a list of connected smart devices will appear on the right side of the screen.
 - 5** Select your desired smart device.
- Android smart devices will automatically attempt to reconnect when they enter the network zone after the initial connection has been established.

Sharing Content with Mobile Connection

You can share and enjoy the content stored on your smart device through your Projector.

- 1** Run the LG TV Plus app installed on your smart device.
 - 2** Set up your desired content on your projector.
- Supported features may vary depending on the version and manufacturer of your smart device's operating system.

Using a Keyboard and Mouse

Using a USB Wired/Wireless Mouse

Connect your mouse to the USB port. Use the mouse to move the pointer on the projector screen and select the menu you want.

- The right button and the special buttons on the mouse do not work.
- When using a wireless USB mouse/keyboard, the experience may be affected by the distance and wireless condition.

Using a USB Wired/Wireless Keyboard

Connect your keyboard to the USB port. You can enter text with the connected keyboard device.

- It is not possible to enter text on some screens.
- It is recommended that you use a product that has been tested for compatibility with LG projectors.
 - LOGITECH K360, LOGITECH K400, LOGITECH K750, LG Electronics MKS-1200
- You can change the input language by pressing the language switch key or the right Alt key. It can also be changed by pressing the Ctrl key and the Space key at same time.
- Wireless USB keyboard use may be affected by the usage range and the wireless environment.
- To enter text in the text field, use the on-screen keyboard on your projector screen or a USB keyboard.

Using a Gamepad

Connect your gamepad to the USB port on the projector if the game requires a gamepad.

- It is recommended that you use a gamepad that has been tested for compatibility with LG projectors.
 - LOGITECH F310, LOGITECH F510, LOGITECH F710, LOGITECH Rumblepad 2, LOGITECH Cordless Rumblepad 2, LOGITECH Dual Action Gamepad, MICROSOFT Xbox 360 Controller (cable), SONY Playstation(R)3 Controller



HOW TO USE VARIETY OF CONTENTS

LG Content Store

You can download and use apps from various categories such as education, entertainment, lifestyle, news, and games.

1 Press the  button on the remote control.

2 Launch the [LG Content Store] application.

- This feature is available in certain countries only.
- Features may be limited in certain countries.
- Content may differ depending upon the model or country.
- Exercise caution when used by children. Children may have access to inappropriate online content through this product.
- You can block inappropriate online content by restricting access to some apps such as the Internet browser. Restrictions can be set in  (**Q. Settings**) →  → [Safety] → [Application Locks].

Recommended Content on the Main Screen

The main screen of the [LG Content Store] shows the most popular content for each category. Select any content to view its details.

- Internet connection is required to use this feature.

Creating Wish List

Using [My Content]



By adding your desired content to [My Content], you can use the content easily and quickly anytime.

- 1** Press the  button on your remote control.
- 2** Select [My Content] in the top left of the screen.
- 3** Select [Add Content].
- 4** Search for content.
- 5** Select your desired content from the search results to add it to [My Content].
 - You can also select from among recommended content shown under the search box and directly add it to [My Content].
 - This feature is only available in certain countries.
 - The type of content you can add to [My Content] may vary depending on the country.
 - You must have a network connection to use this feature.
 - You can move/delete added content in the same way you manage apps.
 - Some of the content services added to [My Content] may not be available if the service has been terminated due to the provider's circumstances.

Account Creating

Creating LG Account



In [Account Management], you can use your email address to create a new LG account.

- 1** Press the  (**Q. Settings**) button on the remote control and select  → [General] → [Account Management].
- 2** Select [CREATE ACCOUNT]. Read and accept the Terms of Service.
- 3** Enter an ID and a password. Your ID must be your email address.
- 4** Enter your birthday.
- 5** Select [OK]. Go to your email to verify your email address. Please verify your email before the time expires.
- 6** Log in with your new account to start using the service.
 - Internet connection is required to create an account.
 - Required information may vary depending upon the country.
 - Existing IDs that do not use an email address can be converted to your email address.
 - You can log in with your Facebook or Google account. (Features other than login may not be available.)
 - You may be restricted from the service depending upon your age.

Account Management

Managing your LG Account

You can manage the information of your LG account.

- 1 Press the  (**Q. Settings**) button on the remote control.
- 2 Go to  → [General] → [Account Management] to log in.

Personal Information

You can view or edit your information of the account currently logged in.

You can change the password or press [EDIT] to edit your personal information.

This feature is available in certain countries only.

Search Content

[Search]

[Search] allows you to find and use a variety of content and information. You can search for files, including image, video, audio files.

Searching for Content

- 1 Run [Search] by pressing the **Q (SEARCH)** button on your remote control.
- 2 Search for a variety of content and information by typing in your desired search terms.

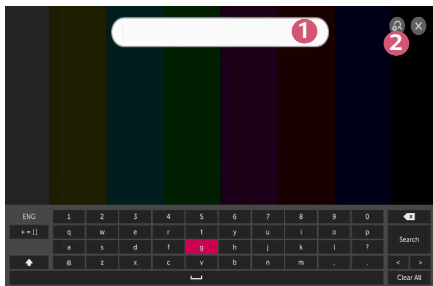

	Description
1	Enter your desired search term.
2	Change the settings of the features provided by [Search]. <ul style="list-style-type: none"> • Some apps provide a feature that lets you search within your projector. If you run a search in such apps, the search will be carried out in [Search].

- Search results may vary depending on the region, network settings, and whether you have agreed to the terms and conditions.

Use App & Contents



Installing Apps

You can use your LG account to install various apps on your projector.

- 1** Press the  button on the remote control.
 - 2** Launch the [LG Content Store] application.
 - 3** Select your desired category from the categories shown at the top of the screen. The list of available apps in the selected category will be shown.
 - 4** Select an app to set up from the list.
 - 5** Read the details of the app and then press [Install].
 - 6** When the installation is complete, you can run the app immediately.
- Available categories may vary depending on the country or service status.
 - If the storage on your projector is insufficient, you can install the apps by connecting an external memory device.
 - Some USB storage devices may not be supported or may not work properly.
 - USB drivers containing apps from other LG TVs or LG Projectors may not be used.

Watching VOD Content

You can immediately enjoy dramas, movies, and more with real-time streaming.

- 1** Press the  button on the remote control.
 - 2** Launch the [LG Content Store] application.
 - 3** Select your desired category from the categories shown at the top of the screen, such as TV Shows and Movies. The list of available content in the selected category will be shown.
 - 4** Select an item from the list.
 - 5** You can play your desired content.
An app may be required to play the content. If not installed, install the app to play the content.
- This feature is only available in certain countries.
 - Available categories may vary depending on the country or service status.
 - To see detailed information about the content, select the title in the bottom and the  area.

PLAY OTHER DEVICE FILES

[Photo & Video]

Viewing Photos and Videos

You can view photos and videos using the [Photo & Video] app.

- 1 Press the  button on your remote control.
- 2 Launch the [Photo & Video] application.
- 3 Select your desired storage device.
- 4 Select and view your desired photo or video.

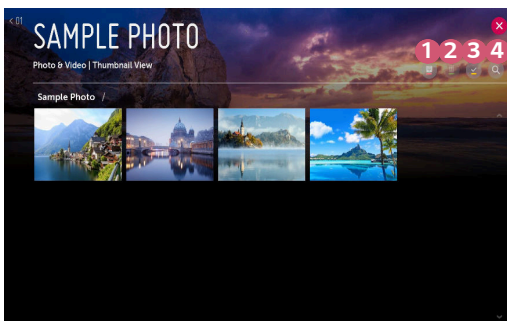

	Description
1	Select your desired type of content and viewing method.
2	Select and delete your desired content. (You cannot delete files that are shared from other devices.)
3	Select the content you want to play. You can only select the same type of content as you first selected.
4	Launch [Search].

- Certain content may not be displayed on the list if the number of all content exceeds 40,000.

Photo Player

Selecting a photo in the [Photo & Video] app runs the photo player. You can view your saved photos.

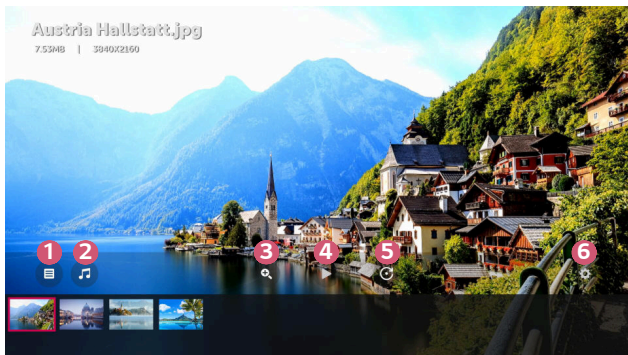

	Description
1	Returns to the entire content list.
2	You can play background music by running the music player.
3	You can zoom the photos in/out.
4	Starts the slide show.
5	Rotates photos.
6	You can set the size of a photo or change the speed and effect of a slide show.

Supported Photo Files

File type	Format	Resolution
.jpeg .jpg .jpe	JPEG	Minimum: 64 x 64 Maximum Normal Type: 15360 (W) x 8640 (H) Progressive Type: 1920 (W) x 1440 (H)
.png	PNG	Minimum: 64 x 64 Maximum: 5760 (W) x 5760 (H)
.bmp	BMP	Minimum: 64 x 64 Maximum: 1920 (W) x 1080 (H)

Video Player

Selecting a video in the [Photo & Video] app runs the video player. You can view your saved videos.

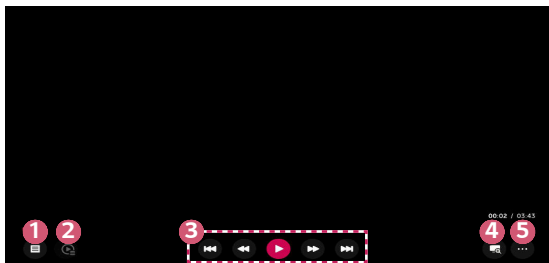

	Description
1	Returns to the entire content list.
2	You can select other content by displaying the playlist while watching a video.
3	You can control basic video playback functions.
4	By zooming in the projector display, you can view images in a larger size than the originals.
5	You can set additional options.

Setting Additional Options

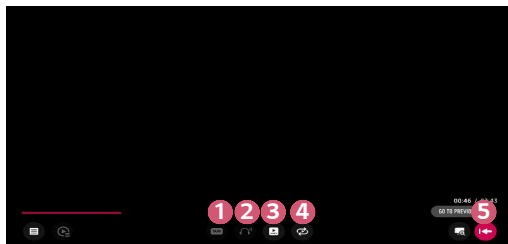

	Description
1	You can change subtitle settings.
2	You can set audio tracks.
3	You can set continue watching to resume playing from the last viewed scene.
4	You can set continuous playback. If continuous playback is set, the next video is automatically played after the playback of a video is over.
5	Returns to the basic operation screen.

Supported Video Files

Maximum data transfer rate:

- Full HD video
 - H.264 1920 x 1080@60P BP/MP/HP@L4.2 40 Mbps
 - HEVC 1920 x 1080@60P MP@L4.1, Main10 Profile@L4.1 40 Mbps

Supported external subtitles:

- *.smi, *.srt, *.sub (MicroDVD, SubViewer 1.0/2.0), *.ass, *.ssa, *.txt (TMPlayer), *.psb (PowerDivX), *.dcs (DLP Cinema)

Supported embedded subtitles format:

- Matroska (mkv) : Sub Station Alpha (SSA), Advanced Sub Station Alpha (ASS), SRT
- MP4 (mp4) : Timed Text

Supported video codecs

Extension	Codec	
.asf .wmv	Video	VC-1 Advanced Profile (except for WMVA), VC-1 Simple and Main Profiles
	Audio	WMA Standard (except for WMA v1/ WMA Speech)
.avi	Video	Xvid (except for 3 warp-point GMC), H.264/AVC, Motion Jpeg, MPEG-4
	Audio	MPEG-1 Layer I, II, MPEG-1 Layer III (MP3), Dolby Digital, LPCM, ADPCM, DTS
.mp4 .m4v .mov	Video	H.264/AVC, MPEG-4, HEVC
	Audio	Dolby Digital, Dolby Digital Plus, AAC, MPEG-1 Layer III (MP3), Dolby AC-4
.3gp .3g2	Video	H.264/AVC, MPEG-4
	Audio	AAC, AMR-NB, AMR-WB
.mkv	Video	MPEG-2, MPEG-4, H.264/AVC, VP8, VP9, HEVC
	Audio	Dolby Digital, Dolby Digital Plus, AAC, PCM, DTS, MPEG-1 Layer I, II, MPEG-1 Layer III (MP3)
.ts .trp .tp .mts	Video	H.264/AVC, MPEG-2, HEVC
	Audio	MPEG-1 Layer I, II, MPEG-1 Layer III (MP3), Dolby Digital, Dolby Digital Plus, AAC, PCM, Dolby AC-4
.mpg .mpeg .dat	Video	MPEG-1, MPEG-2
	Audio	MPEG-1 Layer I, II, MPEG-1 Layer III (MP3)
.vob	Video	MPEG-1, MPEG-2
	Audio	Dolby Digital, MPEG-1 Layer I, II, DVD-LPCM
.rm .rmvb	Video	RV30, RV40
	Audio	Realaudio6 (cook), AAC LC, HE-AAC

- rm, rmvb: This feature is available in certain countries only.
- Dolby AC-4: This feature is available in certain models only.

Cautions for Video Playback

- Some user-created subtitles may not work properly.
- A video file and its subtitle file must be located in the same folder. For subtitles to be displayed properly, make sure that the video file and the subtitle file have the same name.
- Subtitles on a Network Attached Storage (NAS) device may not be supported depending on the manufacturer and model.
- Streams that include Global Motion Compensation (GMC) and Quarterpel Motion Estimation (Qpel) are not supported.
- Playable file sizes may vary depending on the encoding conditions.
- Only Window Media Audio V7 and later are supported.
- The AAC main profile is not supported.
- Video files created by some encoders may not be played.
- Video files in a different format than specified may not be played properly.
- Video files stored on a USB storage device that does not support High Speed may not be played properly.
- DTS codecs are supported only for playbacks of USB and HDMI video files.

[Music]

Playing Music

You can listen to music by using the [Music] app.

- 1 Press the  button on your remote control.
- 2 Launch the [Music] application.
- 3 Select your desired storage device.
You can select your desired songs from all of your storage devices and add them to [MY PLAYLIST].
- 4 Select your desired music content and enjoy it.

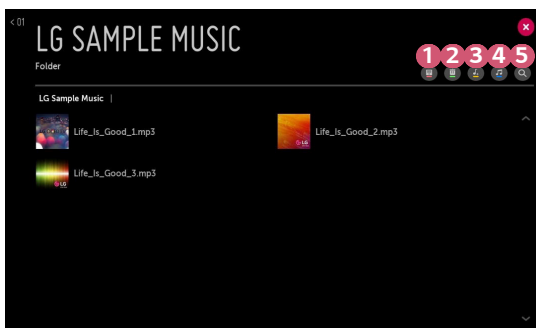

	Description
1	Select the desired type of content list.
2	Select and delete content. (Files shared from other devices cannot be deleted.)
3	Select content and add it to [MY PLAYLIST].
4	Open the music player.
5	Launch [SEARCH].

- If the number of all content is more than 5,000, some content may not be listed up.

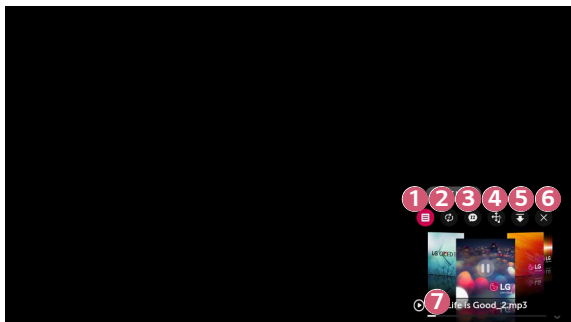

Using the Music Player

The music player lets you choose music from other apps and use it as background music.



	Description
1	You can play music from the selected storage device.
2	You can set repeat playback and random playback.
3	You can listen to music with the screen turned off.

	Description
4	You can change the position of the music player.
5	You can minimize the music player.
6	This feature closes the music player.
7	Lyrics are available for music files that provide them. In some music files, you can choose a lyric section and move the playback position. <ul style="list-style-type: none">• The lyrics feature is only supported on some devices.• The lyrics may not be displayed in sync depending on the lyrics data in the music file.

- Reopen your music player by pressing the    buttons on your remote control.
- You may not be able to use the music player for some features.

Audio Format

File Format	Item	Info
.mp3	Bit rate	32 kbps ~ 320 kbps
	Sample freq.	16 kHz ~ 48 kHz
	Support	MPEG-1, MPEG-2
	Channels	mono, stereo
.wav	Bit rate	-
	Sample freq.	8 kHz ~ 96 kHz
	Support	PCM
	Channels	mono, stereo
.ogg	Bit rate	64 kbps ~ 320 kbps
	Sample freq.	8 kHz ~ 48 kHz
	Support	Vorbis
	Channels	mono, stereo
.wma	Bit rate	128 kbps ~ 320 kbps
	Sample freq.	8 kHz ~ 48 kHz
	Support	WMA
	Channels	up to 6 ch
.flac	Bit rate	-
	Sample freq.	8 kHz ~ 96 kHz
	Support	FLAC
	Channels	mono, stereo

- The number of supported channels may vary depending upon the sample frequency.

[File Viewer]

Viewing Files

You can see document files stored on a connected device.

- 1 Press the  button on your remote control.
- 2 Launch the [File Viewer] application.
- 3 Select your desired storage device.
- 4 Select and view your desired document file.



	Description
1	Select your desired type of content and viewing method.
2	Select and delete your desired content. (You cannot delete files that are shared from other devices.)

- Certain content may not be displayed on the list if the number of all content exceeds 40,000.

Browsing File Viewer

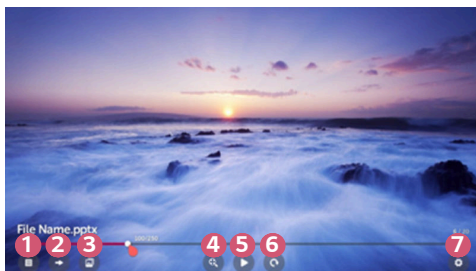

	Description
1	Returns to the entire content list.
2	Moves to the page you specify.
3	Sets the slide show.
4	Enlarges or reduces the document.
5	Starts the slide show.
6	Rotates the document.
7	Sets up the options of File Viewer.

Supported File Formats

File Extension	Supported Version
XLS, XLSX	Microsoft Office 97/2000/2002/2003/2007/2010/ 2013/2016 version
DOC, DOCX	
PPT, PPTX	
TXT	-
PDF	Adobe PDF 1.0/1.1/1.2/1.3/1.4 version
HWP	Hangul 2007 version



- File Viewer realigns a document, so it may look different from what is displayed on a PC.
- For documents that include images, the resolution may look lower during the realigning process.
- If the document is large or has many pages, it may take longer to load.
- Unsupported fonts may be replaced by other fonts.
- The file viewer may not open for Office documents that contain many high resolution images. In that case, reduce the image file size, save it on a USB storage device and run the file viewer again or connect your PC to the projector and open the file on your PC.

Connecting USB

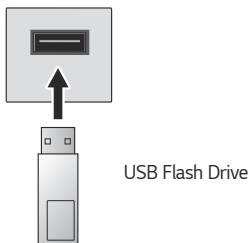
Connect a USB storage device (USB HDD, USB Flash Drive) to the USB port on the projector to enjoy the content files stored on the USB storage device on your projector.



Tips for Using a USB storage device

- A USB storage device that has a built-in automatic recognition program or uses its own driver might not be recognizable.
- Some USB storage devices may not be supported or may not work properly.
- If you use a USB extension cable, the USB storage device may not be recognized or may not work properly.
- Please use only USB storage devices formatted with the FAT32 or NTFS file system provided by Windows OS.
- It is recommended that you use an external USB HDD with a rated voltage of 5 V or less and a rated current of 500 mA or less.
- It is recommended that you use a USB hub or hard disk drive with a power supply. (If the power supplied is not sufficient, the USB storage device may not be detected properly.)
- It is recommended that you use a USB flash drive of 32 GB or less or a USB HDD of 2 TB or less.
- If a USB HDD with power-saving function does not work, turn the hard drive off and on again to make it work properly. See the owner's manual for the USB HDD for more information.
- Data on a USB storage device may be damaged, so it is recommended that you back up any important files. Users are responsible for data management. The manufacturer bears no responsibility.
- Select the connected USB from [INPUTS] and select the [EJECT] button to disconnect the USB storage device.
If you disconnect the USB storage device without selecting [EJECT], an error may occur in your projector or storage device.
You can open [INPUTS] by selecting  (INPUT) → [All Inputs].
- For more information on other connection methods, go to  → [Device Connector].
- Select the connected USB from [INPUTS] and select the [FORMAT] button to format the USB storage device. After format, all the data of USB storage device will be deleted and formatted as NTFS or FAT32 file system.
- When connecting a USB storage device, a random file/folder can be created to provide Smart projector services such as the saving and retrieving of thumbnail images.

Share Smart Phone

Content Share with Smartphone

Content Share allows you to enjoy videos, music, and photos saved on your Smartphone that is connected to the same network.

Connecting to a smartphone with your projector

- 1 Press the  button on the remote control.
- 2 Launch the [Device Connector] application.
- 3 Select the [Smartphone].
- 4 Follow instructions in [Device Connector].



Matters that require special attention during Content Share

- Check your network settings if the Content Share option does not work properly.
- May not work properly on a wireless network. It is recommended that you connect to a wired network.
- May not work properly depending upon the network environment.
- If multiple display devices are connected to one device, the content may not be played properly depending upon server performance.
- To watch the 1080p video through Content Share function, a router that uses 5 GHz frequency is required. If a 2.4 GHz router is used, the video may not play properly.
- Captions are only supported on some connected devices.
- When a subtitle file is added later, disable the shared folder and then enable it again.
- The DRM files in the connected device will not play.
- Even for the file format supported by the projector, the supported file format may differ depending upon the connected device environment.
- If there are too many folders or files in a folder, it may not work properly.
- The information on the file imported from the connected device may not be displayed correctly.
- Depending upon the encoding, some streams may not play in Content Sharing mode.

Share Smartphone Screen

To see the Mobile Device's screen on the projector

- 1** Enable Miracast mode on the mobile device.
 - 2** Your projector will be displayed in the list of available devices.
 - 3** Select your projector and request connection.
 - 4** To start the connection; a message saying "Connecting..." will appear.
 - 5** After the connection is established, the projector will display the screen of the connected device.
- Always update your device to be connected to your projector to the latest OS version for a reliable connection.
 - A non-LGE device might not connect even when it is detected.
 - Connect the device to a 5 GHz router because the performance may be affected by your wireless environment.
 - The response rate may vary, depending upon the user's environment.
 - It differs among devices. For more information on the device you want to connect to, refer to its user guide.
 - If connection fails repeatedly, turn off the projector and the device you want to connect to, then turn them back on and try again.

Share Computer Content

What Is Content Share?

Content Share allows you to enjoy videos, music and photos saved on your PC.

Play the content with sharing software on the PC

If you have Windows 7 or later installed on your PC, you can play music, video, photos, etc. on your projector without needing to install a separate program.

- 1** Connect you projector and PC to the same network. PCs installed with Windows 7 or later also need to be connected to a network.
 - 2** Right-click the desired music/video/photo file you wish to play, then select your model using the “Play To” feature built into Windows 7 or later to play the file.
To play on other devices like your mobile phone, refer to the relevant user guide.
- Even when multiple projectors or devices are connected, the selected file is played through only one device. The playback rate may vary depending on the network connection.

Use the SmartShare PC Software to play the content saved on the PC

You can use SmartShare PC Software to connect the music/videos/photos saved on the PC to your home network and play them on your projector.

- 1** Configure the projector and PC installed with SmartShare on the same network.
 - The SmartShare service is only available when the projector and server PC are connected to a single router.
- 2** Download and install SmartShare PC Software from the LG website. Before installation, exit all programs running on the PC, such as a firewall or an anti-virus software.
- 3** Run SmartShare PC Software and configure the share settings.
- 4** Shared videos and photos are played from the [Photo & Video] app on the projector. Shared music files are played from the [Music] app on the projector.
 - The server should be running in order to watch the shared file on your projector.
 - You can check the website information from  → [Device Connector] → [PC] → [CONTENT SHARE].
 - For information on how to use the SmartShare PC Software, refer to the software's help section.

Matters that require special attention during Content Share

- Check your network settings if the Content Share option does not work properly.
- May not work properly on a wireless network. It is recommended that you connect to a wired network.
- If multiple display devices are connected to one device, the content may not be played properly depending on server performance.
- May not work properly depending on the network environment.
- To watch the 1080p video through Content Share function, a router that uses 5 GHz frequency is required. If a 2.4 GHz router is used, the video may not play properly.
- The Content Share function may not be supported for a router that does not support multi-cast. For more information, refer to the user guide that came with your router or contact the manufacturer.
- Captions are only supported on some connected devices.
- SmartShare PC Software is recommended for reading captions.
- When a subtitle file is added later, disable the shared folder and then enable it again.
- The DRM files in the connected device will not play.
- Even for the file format supported by the projector, the supported file format may differ depending on the connected device environment.
- If there are too many folders or files in a folder, it may not work properly.
- The information on the file imported from the connected device may not be displayed correctly.
- Depending upon the encoding, some streams may not play in Content Sharing mode.

Share Computer Screen

To see the PC screen on the projector

Connect wireless

- 1 Press the  button on the remote control.
 - 2 Run the [Screen Share] app.
 - 3 Launch Miracast on the PC. Your projector will be displayed in the list of available devices.
 - 4 Select your projector and request connection.
 - 5 After the connection is established, the projector will display the screen of the connected device.
- Always update your device to be connected to your projector to the latest OS version for a reliable connection.
 - It is recommended that you use this function at close range.
 - Though it can be connected without a wireless router, connecting your device to a 5 GHz router is recommended because the performance can be affected by the surrounding wireless environment.
 - It supports the connection over the Intel® WiDi 3.5 version.
 - The response rate may vary, depending upon the user's environment.
 - It's different from Windows version. For more information on the device you want to connect to, refer to its user guide.
 - For more information, refer to the [Screen Share] app.
 - If connection fails repeatedly, turn off the projector and the device you want to connect to, then turn them back on and try again.

Connect wired

Connect the PC with projector by HDMI cable.

BENEFITS OF SMART PROJECTOR

Zooming in the Projector Display

By zooming in the projector screen, you can view images in a larger size than the originals.

Press the **LIVE ZOOM** button on your remote control while watching projector or in video playback. You can also press the [START LIVE ZOOM] button in the lower-right corner of the screen.

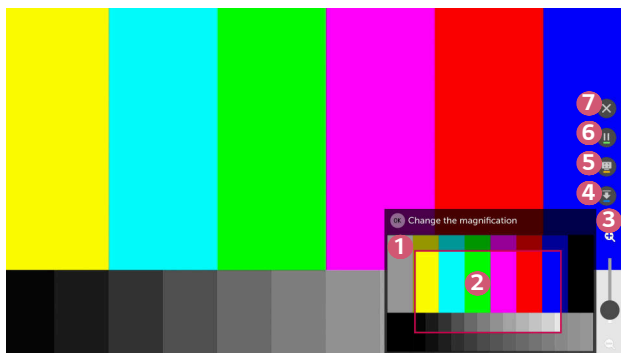





	Description
①	The original screen before enlargement is displayed on the subscreen.
②	This indicates the enlarged area that is displayed on the main screen.
③	You can zoom in and out on the main screen using the magnification bar. You can adjust the magnification by scrolling with the Wheel (OK) button on the Magic Remote.
④	You can hide the sub screen.

	Description
5	You can capture your current screen. You can view captured images in the [Photo & Video] app.
6	You can pause or resume your current screen.
7	Close the function and return to the original screen.

- To exit the feature and return to the original screen, press **LIVE ZOOM** or **BACK**.
- If you run another app on an enlarged screen, the feature closes.

Moving the Position of an Enlarged Screen

- Method 1. On the main screen, move the pointer on the Magic Remote to your desired position and press **Wheel (OK)** button. The position you select will move to the center of the screen.
- Method 2. Drag the main screen using the Magic Remote's pointer to the desired position.
- Method 3. On the subscreen, select the area you want to enlarge using the Magic Remote.
- Method 4. Using the pointer on your Magic Remote, drag the enlarged area on the subscreen into your desired position.
- You can also move the screen using the / / /  buttons on your remote control.

Enjoying Internet

Using the [Web Browser]

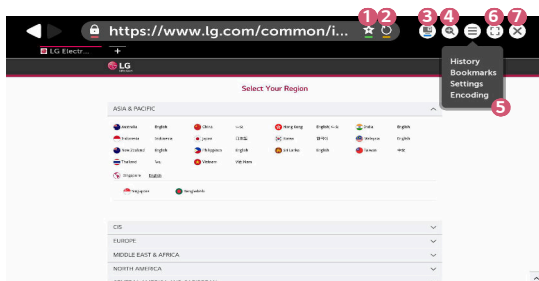

You can enter the website when you input the web address on the URL bar. If you input the search word, it will find the information about search word base on the search engine.

- 1 Press the  button on the remote control.
- 2 Launch the [Web Browser] application.



	Description
1	You can add the current page to the Home screen, or add or delete the current page in [Bookmarks]. (A page added to the home screen can only be deleted on the home screen. In this case, it is not deleted from [Bookmarks].)
2	Reloads the current page.
3	You can turn on/off Mini TV.

	Description
4	Zooms in or out of the screen.
5	[History] : You can open or delete the history list. [Bookmarks] : You can open or delete the bookmark list. [Settings] : You can configure simple settings for the browser. [Encoding] : You can change the language when the content is not properly displayed on the web page.
6	You can use the browser in full screen mode. To go back to the original screen, use the Remote Control to move the pointer to the top of the screen. [Exit Full Screen] will display.
7	Exit the [Web Browser].

- The [Web Browser] supports only HTML5 media, it does not support Flash Plug-in.
- The [Web Browser] does not support plug-in installation.
- On the [Web Browser], it may not be possible to play media files in formats other than JPEG/PNG/GIF
- The [Web Browser] may be closed if there is insufficient memory space.
- On the [Web Browser], only fonts embedded in the projector are used. Therefore, text may be displayed in different fonts than the ones on the PC.
- The [Web Browser] does not support file and font downloads.
- Since the [Web Browser] is a projector browser, it may function differently than PC browsers.
- Since the [Web Browser] is a projector browser, some of the content may not play properly.
- Caution is required for children accessing inappropriate content since this product can be connected to the Internet.
- Access to some of the apps, including the Web Browser, may be restricted in order to block inappropriate online content.
- Configure the settings in  (**Q. Settings**) →  → [Safety] → [Application Locks].

Setting the [Web Browser]

Press  at the top of the screen and select the [Settings].

- [On Startup]
You can set the startup page of the browser to [Open the New Tab page]/[Continue where I left off]/[Home page:].
- [Search Engines]
You can select the default search engine.
- [Recommended Sites]
You can change the settings so that [Recommended Sites] are displayed. The [Recommended Sites] and [Most Visited Sites] are displayed on a new tab. The [Recommended Sites] may not be available in your country. To hide the [Recommended Sites], choose [Off] in [Settings].
- [Always Show Bookmarks Bar]
You can change the settings so that the [Bookmarks] bar is always displayed.
- [Private Browsing]
You can configure the settings not to leave records after searching.
- [Site Filtering]
To use the [Site Filtering] function, you should enter the projector password. The initial password is set as "0000".
 - [Approved Sites] : You can configure the settings to open the previously registered web pages only.
 - [Blocked Sites] : You can configure the settings to block specific websites.
- [Pop-up Blocker]
You can block pop-ups using the settings.
- [Do Not Track]
You can request your visit history not be recorded in the server.
- [Adaptive Streaming using JavaScript]
If this is set to [Off], the resolution of the videos played in Web Browser is limited to 720p.

Playing Sound from a Smart Device through the Projector's Speakers

Connect a smart device to the projector via Bluetooth to play sound from the smart device through the projector's speakers.

- 1** Press the  button on the remote control.
- 2** Launches [Bluetooth Audio Playback].
- 3** Turn the smart device's Bluetooth on, then select the projector from the list of devices.
- 4** The projector will be connected to the smart device.

Notifications

Using [Notifications]

The [Notifications] transfers real-time notifications from various apps and LG services. It shows the status of apps that are currently running and allows you to view, delete, and run all notifications in one place.

- 1 Press the  button on the remote control.
- 2 Launch the [Notifications] application.

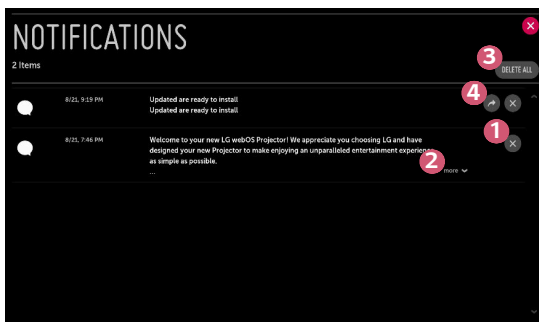

	Description
1	You can delete notifications.
2	For notifications with long content, press [more] to open them in full view.
3	You can delete all notifications.
4	You can launch the APP or move to URL.

TOUR LIST OF SETTINGS

The options may differ depending on the model.

Quick Settings

To use Setting function quickly

Press the  (**Q. Settings**) button on the remote control.

Displays a set of light-weight controls quickly and simply such as [Picture Mode], [Aspect Ratio], [Sound Out] and so on.

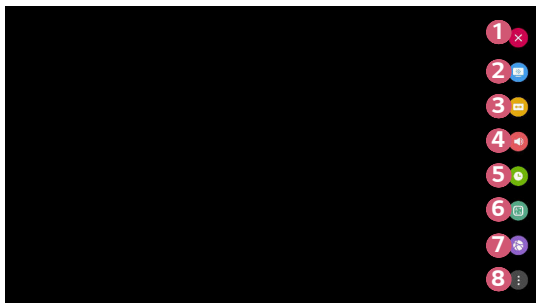

	Description
1	Closes the Quick settings.
2	You can set the [Picture Mode].
3	You can set the [Aspect Ratio].
4	You can choose the [Sound Out].
5	You can set the [Sleep Timer].
6	You can set the [PJT Mode].
7	Allows you to view connected [Network].
8	You can set more options.

[Picture] Settings

[Picture Mode]

 (Q. Settings) →  → [Picture] → [Picture Mode Settings] → [Picture Mode]

Select the picture mode that is best suited to your viewing environment, preferences or video type.

The options may differ depending on the model.

Depending upon the input signal, the available picture modes may be different.

When watching online service content, the Picture Mode may be changed to match the content being shown.

- [Vivid]
Sharpens the image by increasing the contrast, brightness, and sharpness.
- [Standard]
Displays the picture with normal contrast, brightness, and sharpness levels.
- [Cinema]
Optimizes the screen for movies.
- [Sports]
Optimizes the screen for sports games. Sharpens the image of rapid movements such as kicking or throwing a ball.
- [Game]
Optimizes the screen for gameplay.
- [Expert (Bright Room)]/[Expert (Dark Room)]
Allows an expert, or anyone who loves picture quality, to tune to the best picture quality.

[Picture Mode Settings]



 **(Q. Settings)** →  → [Picture] → [Picture Mode Settings]

This feature allows you to adjust the selected picture mode in detail.



- [Contrast]
Adjusts the contrast of the bright and dark areas of the picture. The closer to 100, the higher the contrast.
- [Brightness]
Adjusts the overall screen brightness. The closer to 100, the brighter the screen.
- [Sharpness]
Adjusts the sharpness of the image. The closer to 50, the sharper and clearer the image.
- [Colour]
Tones down or up the colours displayed on the screen. The closer to 100, the deeper the colour.
- [Tint]
Adjusts the colour balance between red and green displayed on the screen. The closer to Red 50, the more red the colour will be. The closer to Green 50, the more green the colour will be.
- [Colour Temperature]
Adjusts the colour temperature cool/medium/warm/natural.
 - The settings you specify only applies to the currently selected input mode. To apply your current picture settings to all input modes, select [Apply to All Inputs].
 - Depending upon the input signal or the selected picture mode, the available options may differ.
- [Apply to All Inputs]
Save the current customized setting values to currently selected picture mode for all inputs.
- [Reset]
This option will reset the picture settings.
 - You can reset the picture modes separately. Select the picture mode you wish to reset and enable it.

[Advanced Controls]/[Expert Controls]

Adjust screen settings for individual picture modes.

 **(Q. Settings)** →  → [Picture] → [Picture Mode Settings] → [Advanced Controls]



- [Dynamic Contrast]
Corrects the difference between the bright and dark areas of the screen for optimal results depending on the brightness of the picture.
- [Dynamic Colour]
Adjusts the colour and saturation of the picture to make the image more colourful and lively.
- [Preferred Colour]
Adjusts the colours of skin, grass and sky to your personal preferences.
- [Colour Gamut]
Selects the range of colours to display.
- [Super Resolution]
Adjusts the resolution to make dim and blurred images clearer.
- [Gamma]
Adjusts the medium brightness of the picture.

 (Q. Settings) →  → [Picture] → [Picture Mode Settings] → [Expert Controls]

If you set the picture mode to Expert, you can set the following functions.

- [Dynamic Contrast]
Corrects the difference between the bright and dark areas of the screen for optimal results depending on the brightness of the picture.
- [Super Resolution]
Adjusts the resolution to make dim and blurred images clearer.
- [Colour Gamut]
Selects the range of colours to display.
- [Colour Filter]
Filters a specific colour spectrum in RGB colours to fine-tune colour saturation and hue accurately.
- [Gamma]
Adjusts the medium brightness of the picture.
- [White Balance]
Adjusts the overall colour temperature of the screen as desired.
- [Colour Management System]
This is a function used by experts when they adjust Colours using a test pattern of six colours ([Red]/[Green]/[Blue]/[Cyan]/[Magenta]/[Yellow]) without affecting other colour areas. For normal images, adjustments may not result in noticeable colour changes.
 - Depending upon the input signal or the selected picture mode, the available options may differ.



[Picture Options]

 **(Q. Settings)** →  → [Picture] → [Picture Mode Settings] → [Picture Options]

Adjust detailed settings to further optimize the picture.

- [Noise Reduction]
Removes small dots that stand out so as to make the image clean.
- [MPEG Noise Reduction]
Reduces the noise produced during the creation of digital video signals.
- [Black Level]
Compensates the screen brightness and contrast by adjusting the darkness of the screen.
- [TruMotion]
This feature is available on certain models only.
Optimizes the image quality of fast-moving pictures.
 - [Off]: Turns off the [TruMotion].
 - [Smooth]: Softens fast-moving pictures.
 - [Clear]: Makes fast-moving pictures clearer.
 - [User]: Sets [De-Judder]/[De-Blur] manually.
 - [De-Judder]: Adjusts juddering on the screen.
 - [De-Blur]: Reduces the blurring effects of motion.
- The advanced settings can be changed only in [User] mode.
- Depending upon the input signal or the selected picture mode, the available options may differ.
- The configurable items differ depending upon model.

[Aspect Ratio]



 **(Q. Settings)** →  → [Picture] → [Aspect Ratio Settings] → [Aspect Ratio]

The options may differ depending on the model.

Depending upon the input signal, the available screen sizes may be different.

- [16:9]
Displays an aspect ratio of 16:9.
- [Original]
Changes the aspect ratio to 4:3 or 16:9 depending upon the input video signal.
- [4:3]
Displays an aspect ratio of 4:3.
- [Vertical Zoom]
You can adjust the vertical dimension of the screen and align the screen vertically by using [Adjust Zoom Ratio] and [Adjust Screen Position].
- [All-Direction Zoom]
You can adjust the horizontal/vertical/diagonal dimensions of the screen and align the screen horizontally/vertically by using [Adjust Zoom Ratio] and [Adjust Screen Position].

[Just Scan]



 **(Q. Settings)** →  → [Picture] → [Aspect Ratio Settings] → [Just Scan]

If you turn this feature [On], you can view the content in the aspect ratio that is in content source. If the edge of the screen is not clean, please turn it [Off].

If set to [Auto], the feature switches between [On] or [Off] status depending on the information contained in the video signal.

- The items that can be selected may vary depending on the current input.

[Energy Saving]

 **(Q. Settings)** →  → [Picture] → [Energy Saving]

Reduces power consumption by adjusting peak screen brightness.

- [Off]/[Minimum]/[Medium]/[Maximum]
Applies the pre-set [Energy Saving] mode.

[Picture Test]



 **(Q. Settings)** →  → [Picture] → [Picture Test]

First of all, start the Picture Test to see whether the video signal output is normal, and then select whether there is an error.

If there are no problems in the test picture, check the connected external device.



[Sound] Settings

[Sound Mode]

 (Q. Settings) →  → [Sound] → [Sound Mode Settings] → [Sound Mode]

- [Standard]
Optimizes the sound for all types of content.
- [Cinema]
Optimizes the sound for cinemas.
- [Clear Voice III]
Boosts voice clarity.
- [Sports]
Optimizes the sound for sports.
- [Music]
Optimizes the sound for music.
- [Game]
Optimizes the sound for gameplay.

[Sound Mode Settings]

 (Q. Settings) →  → [Sound] → [Sound Mode Settings]

You can only use [Virtual Surround Plus], [Equalizer], and [Reset] if [Sound Mode] is set to [Standard].



The options may differ depending on the model.

- [Sound Mode]
You can select the most suitable sound mode for each genre.
- [Balance]
You can adjust the volume of the left and right speakers.
- [Virtual Surround Plus]
Enjoy an immersive soundscape with the virtual multi-channel surround sound effect.
- [Equalizer]
You can set the desired sound by adjusting the equalizer directly.
(100 Hz/300 Hz/1 kHz/3 kHz/10 kHz)
- [Reset]
You can reset the sound effect settings.

[Sound Out]

The options may differ depending on the model.

Playing audio through the projector's internal speakers

 **(Q. Settings)** →  → [Sound] → [Sound Out] → [Internal Projector Speaker]

Audio is played through the projector's internal speakers.

Connecting and Using an Audio Device Supporting Optical

 **(Q. Settings)** →  → [Sound] → [Sound Out] → [Optical]

You can connect an audio device that supports [Optical] to the optical digital audio output port to enjoy your projector's sound in richer quality and greater convenience.

- Only available for models with an optical digital port.
- You can use the projector remote control to adjust the volume of the connected device.



Hearing Sound through an External Audio Device Connected via a HDMI (ARC) Port

 **(Q. Settings)** →  → [Sound] → [Sound Out] → [HDMI ARC]

Sound from the projector can be output through an external audio device connected via a HDMI (ARC) port.

- Select [HDMI ARC] to automatically turn on SIMPLINK. Once SIMPLINK is turned off, the output speaker settings automatically revert to the default settings for uninterrupted audio output.

Configuring digital sound output settings



 (Q. Settings) →  → [Sound] → [Sound Out] → [Optical]/[HDMI ARC] → [Digital Sound Out]

You can configure the [Digital Sound Out] settings.

- These settings are available only when an [Optical]/[HDMI ARC] is selected.

	Sound Input	Digital Sound Output
[Auto]	MPEG	PCM
	Dolby Digital	Dolby Digital
	Dolby Digital Plus	(Optical) Dolby Digital (HDMI ARC) Dolby Digital Plus
	HE-AAC	Dolby Digital
	DTS	DTS / PCM
	DTS Express	DTS / PCM
	DTS-HD MA	PCM / DTS
[PCM]	All	PCM

Connecting and Using an Audio Device Supporting LG Sound Sync

 (Q. Settings) →  → [Sound] → [Sound Out] → [Optical] → [LG Sound Sync]

You can connect an audio device that supports [LG Sound Sync] to the optical digital audio output port to enjoy your projector's sound in richer quality and greater convenience.

- Only available for models with an optical digital port.
- You can use the projector remote control to adjust the volume of the connected device.



Connecting and Using an Audio Device Wirelessly

 (Q. Settings) →  → [Sound] → [Sound Out] → [Bluetooth]

You can connect wirelessly a Bluetooth audio device or a Bluetooth headset to enjoy your projector's sound in richer quality and greater convenience.

- If you have recently connected device that the sound bar supports LG Sound Sync, this feature automatically tries connecting to that device.
- In some devices, this feature automatically tries connecting to the recently connected device when the projector is turned on.
- We recommend that you connect an LG audio device that supports LG Sound Sync, using LG TV mode or LG Sound Sync mode on device.
- Press [DEVICE SELECTION] to view the connected devices or the devices that can be connected to connect any one of them.
- You can use the projector remote control to adjust the volume of some Bluetooth devices.
- If the device fails to connect, check the power of the device to connect to and check if the audio device is working properly.
- Depending on the type of the Bluetooth device, the device may not connect correctly or an abnormal behavior may occur such as unsynchronized video and audio.
- Sound may stutter or sound quality may be reduced if:
 - the Bluetooth device is too far from the projector;
 - there are obstacles between the Bluetooth device and the projector; or
 - used together with radio equipment such as a microwave oven or wireless LAN.
- If the [Picture Mode] is set to [Game] and [Sound Out] is set to [Bluetooth], [Picture Mode] changes to [Standard].
- Using Bluetooth speakers that support Dual mode/Double mode/2-Channel mode together with the Magic Remote may limit the speakers' usability.





Using Audio Out (Line Out)/Wired Headphones

 **(Q. Settings)** →  → [Sound] → [Sound Out] → [Wired Headphones]
Select [Wired Headphones] to optimize audio output according to the device connected.

- Some models may support the [Wired Headphones] function only.
- If you connect the wired headphones while the projector is powered on, it automatically detects the wired headphones and redirects audio through them.
- This feature is only available in certain countries.

Playing audio through the projector's internal speakers and external audio device simultaneously

Audio can be played through multiple devices simultaneously.

- Using [Internal Projector Speaker + Optical]
 **(Q. Settings)** →  → [Sound] → [Sound Out] → [Internal Projector Speaker + Optical]
 - Audio is played through the projector's built-in speakers and the audio device connected to the digital optical audio output port simultaneously.
- Using [Internal Projector Speaker + Wired Headphones]
 **(Q. Settings)** →  → [Sound] → [Sound Out] → [Internal Projector Speaker + Wired Headphones]
Audio is played through the projector's internal speakers and the [Wired Headphones] simultaneously.
 - If you connect the wired headphones while the projector is powered on, it automatically detects the wired headphones and redirects audio through them.
 - This feature is only available in certain countries.

[Auto Volume]

 **(Q. Settings)** →  → [Sound] → [Auto Volume]

Click [On] to adjust the volume level automatically.

This feature is available on certain models only.

[AV Sync Adjustment]

 **(Q. Settings)** →  → [Sound] → [AV Sync Adjustment]

Adjusts the synchronization of the sound from the speaker that is working.

The closer to (+), the slower the audio output.

If you select the [Bypass], Outputs the sound from external devices without any audio delay. The audio may be output before the video because of the time the projector takes to process the video input.

[Sound Test]

 **(Q. Settings)** →  → [Sound] → [Sound Test]

Start the [Sound Test] to check that the sound signal output is normal, and then select whether there is an error.

If there are no problems in the test, check the connected external device.

- Sound test is possible by Internal projector Speaker only.

[Network]

[Projector Name]

 (Q. Settings) →  → [Network] → [Projector Name]

You can use the screen keyboard to set the name for the smart projector to be used on the network.

- Up to 30 characters can be entered using the English alphabet.

[Wired Connection (Ethernet)]

 (Q. Settings) →  → [Network] → [Wired Connection (Ethernet)]

The projector will be connected automatically to the network if a cable connection is established.

To change network connection settings, select [Edit] in Network Settings.



[Wi-Fi Connection]

 (Q. Settings) →  → [Network] → [Wi-Fi Connection]

If you have set up the projector for a wireless network, you can check and connect to the available wireless Internet networks.

- [Add a hidden wireless network]
If you input the name of network directly, you can add a wireless network.
- [Connect via WPS PBC.]
Connects easily when the button of a wireless AP supporting PBC is pressed.
- [Connect via WPS PIN.]
Connects easily when the PIN of the wireless AP that you wish to connect to is entered in to the AP configuration webpage.
- [Advanced Wi-Fi Settings]
If you input the information of network directly, you can enter a wireless network.

[Wi-Fi Direct]

 **(Q. Settings)** →  → [Network] → [Wi-Fi Direct]

[Wi-Fi Direct] is a function that allows your projector to connect with a Wi-Fi Direct-enabled device without a Wireless Router. You can open files stored on the devices that are connected via Wi-Fi Direct in the [Photo & Video] app and the [Music] app.

- 1** Enable Wi-Fi Direct on the device to which you want to connect.
- 2** A list of devices that can be connected to the projector is displayed.
- 3** Select a device to connect.
- 4** If the desired device accepts the request, Wi-Fi Direct will be connected.
- 5** From your desired connected device, select the video, music and photo files that you want to open on your projector via the LG TV Plus app or the content sharing feature.
- 6** You can open files stored on the devices that are connected via Wi-Fi Direct in the [Photo & Video] app and the [Music] app.
 - If a device that was previously connected to the projector sends a connection request again, it will be connected automatically.
 - If you launch the [Screen Share] app while Wi-Fi Direct is connected, Wi-Fi Direct will disconnect.

[LG Connect Apps]

 **(Q. Settings)** →  → [Network] → [LG Connect Apps]

[LG Connect Apps] Provides apps, like photo sharing or mobile-device remotes, with the ability to access and control certain features of your projector.

Set the [LG Connect Apps] option to [On]. (When you stop using it, please change it back to [Off].)

- If you want to disconnect all devices from your projector, click the [DISCONNECT ALL CONNECTIONS] on your screen.

[General]

[Language]

 (Q. Settings) →  → [General] → [Language]

You can choose the menu language displayed on the screen.

- [Menu Language]
You can select one of the menu languages to be displayed on the screen.
- [Keyboard Languages]
Select the language to use the on-screen keyboard.

[Location]

 (Q. Settings) →  → [General] → [Location]



You can change the location setting of your smart projector.

You must set the country manually when you are not connected to the network.

The configurable items differ depending upon the country.

- [Service Area Postcode]
This function is used to set the receiving location of the projector by entering your postcode.
- [LG Services Country]
If you don't set the [Set Automatically], you can select the country manually.

[Time & Date]

 **(Q. Settings)** →  → [General] → [Time & Date]

You can check or change the time while watching the projector.

- [Set Automatically]
Automatically sets the time displayed on the projector screen by network.
- [Time]/[Date]/[Time Zone]
You can set the time and date manually if the automatically set current time is incorrect.
- [Custom Time Zone]
When select the [Custom] in [Time Zone], [Custom Time Zone] menu is activated.



[Sleep Timer]

 **(Q. Settings)** →  → [General] → [Timers] → [Sleep Timer]

Sets the projector to turn off at a specified time.

If you want to disable [Sleep Timer], select [Off].

[Timer Power On]/[Timer Power Off]

 **(Q. Settings)** →  → [General] → [Timers] → [Timer Power On]/[Timer Power Off]

You can set the power on/off time for the projector.

Select [Off] if you are not going to set [Timer Power On]/[Timer Power Off].

- To use [Timer Power On]/[Timer Power Off], set the time correctly.

[Auto Off]

 **(Q. Settings)** →  → [General] → [Timers] → [Auto Off]

If there is no input signal or button press, the projector automatically turns off after the preset time has elapsed.

[Account Management]

 (Q. Settings) →  → [General] → [Account Management]

Manage your account information and settings.

- This feature is available on certain models only.

[Eco Mode]

 (Q. Settings) →  → [General] → [Eco Mode]

Set power options to reduce energy consumption.

- [Auto Power Off]
Set the projector to turn off automatically when there has been no user input for a specified amount of time.
- [HDD Eco Mode]
If you set the mode to [On], the USB HDD connected to the projector will go into power-saving mode when it has been left unattended for an extended period of time.

[Mobile Projector On]

 **(Q. Settings)** →  → [General] → [Mobile Projector On]

If [Turn on via Wi-Fi] or [Turn on via Bluetooth] is set to [On], you can turn on your projector using an application that supports [Mobile Projector On] or see the screen of the application on your projector.

- The [Turn on via Wi-Fi] feature must be used in an app on a smart device that supports the feature.
- The [Turn on via Bluetooth] feature can only be used with certain LG Electronics smartphones.
- The projector should be connected to a network.
- The projector must be plugged in.
- The projector and the device to be used should be connected to the same network.
- To connect for the first time, make sure the device to be used is ready to connect.
- This function is available on certain models or in certain countries only.

[SIMPLINK (HDMI-CEC)]

 **(Q. Settings)** →  → [General] → [SIMPLINK (HDMI-CEC)]

You can conveniently control and use various multimedia devices connected through HDMI with the projector remote control.

[Edge Adjustment]

 (Q. Settings) →  → [General] → [Edge Adjustment]

[Edge Adjustment] (4 Corner Keystone) adjusts the horizontal and vertical sides of the projected image if the projector is at an angle and not perpendicular to the screen. This feature ensures the shape of the projected image is not distorted.

Use this feature only when the projector cannot be set up at the optimal angle.

[Edge Adjustment] may result in a loss of image quality.



- The value range of [Edge Adjustment] is as follows.
 - [Top Left] (H: 0 to 100, V: 0 to 100)
 - [Top Right] (H: -100 to 0, V: 0 to 100)
 - [Bottom Left] (H: 0 to 100, V: -100 to 0)
 - [Bottom Right] (H: -100 to 0, V: -100 to 0)

[PJT Mode]

 (Q. Settings) →  → [General] → [PJT Mode]

This function turns the projected image upside down or flips horizontal.

[Auto Keystone]

 (Q. Settings) →  → [General] → [Auto Keystone]



This feature is available on certain models only.

[Auto Keystone] provides a rectangular screen image by automatically adjusting the keystone number when there is a trapezoidal screen image caused by tilting of the projector.

Use the [Edge Adjustment] (4 Corner Keystone) if you want a more accurate calibration of the screen than the [Auto Keystone].

- [On]
Automatically adjusts the keystone number.
- [Off]
Manually adjusts the keystone number.



[Auto Power]

 **(Q. Settings)** →  → [General] → [Auto Power]

Makes the projector turn on automatically when the power cord is connected to the projector.

- [On]
When the power cord is connected to the projector, it turns on automatically.
- [Off]
When the power cord is connected to the projector, it goes into standby mode.

[High Altitude]

 **(Q. Settings)** →  → [General] → [High Altitude]

If the projector is used at an altitude higher than 1200 meters, turn this on. Otherwise, the projector may overheat or its protection function may be activated. If this happens, turn the projector off and then on again after waiting for several minutes.

- This feature is available on certain models only.



[LG Wireless Keyboard]

 **(Q. Settings)** →  → [General] → [LG Wireless Keyboard]

This feature enables you to connect a LG wireless keyboard to your device. Turn on the device, set it to pairing mode, and then click [CONNECT] on your projector screen.



- Supported keyboard
 - LG Rolly Keyboard
- If there is a LG wireless keyboard previously connected, it will be automatically reconnected to your projector once your projector turns on.
- To disconnect the existing connection, click [DISCONNECT].
- This feature is available on certain models only.

[Settings Help]

 **(Q. Settings)** →  → [General] → [Settings Help]

If you select the setting menus, you will see the hints of the settings. Turn on/off description box in settings.

[Screen Saver]

 **(Q. Settings)** →  → [General] → [Screen Saver]

When the currently displayed app has not received any user input for an hour, it will be replaced by a [Screen Saver].

[Reset to Initial Settings]

 **(Q. Settings)** →  → [General] → [Reset to Initial Settings]

Return projector to its initial settings. This will revert all settings to their default values.

After reset, the projector will automatically turn off and on.



- If [Safety] is set to [On], you should type the password to [Reset to Initial Settings].
- Do not turn off the power during initialization.
- We recommended that you reset the projector to [Reset to Initial Settings] before you sell it or transfer it to a third party.

[About This Projector]

 **(Q. Settings)** →  → [General] → [About This Projector]

You can check the information about Customer Services. (Software Update, projector Information, and so on.)

[Self Diagnosis]

 **(Q. Settings)** →  → [General] → [Self Diagnosis]



Troubleshoots functional problems that can arise while using the product.

[User Agreements]

 **(Q. Settings)** →  → [General] → [User Agreements]

Review legal documents and accept or decline their terms of service.

[Legal Notice]

 **(Q. Settings)** →  → [General] → [Legal Notice]

Review legal notice.

[Home/Store Mode]

 **(Q. Settings)** →  → [General] → [Home/Store Mode]

You can choose between [Home Mode] and [Store Mode].



To use the projector at home, select [Home Mode].

[Store Mode] only when the projector will be displayed in store. Select the Store mode for settings optimized for store display.

[Safety] Settings

- Set [Safety] to [On].
- The initial password is set as "0000".
When France is selected for Country, password is not "0000" but "1234".
- The configurable items differ depending upon model.



[Application Locks]

 (Q. Settings) →  → [Safety] → [Application Locks] → Select the Applications to lock.

You can lock or unlock the application.



- The lock function is not immediately available for the currently running application.

[Input Locks]

 (Q. Settings) →  → [Safety] → [Input Locks] → Select the Inputs to lock.

You can lock or unlock the Input Locks.







[Reset Password]

 (Q. Settings) →  → [Safety] → [Reset Password]

Set or change the password for the projector.

Resetting a Lost Password

If you lose the password you set, you can reset it as follows:

- 1 Press the  (Q. Settings) button on the remote control and move the focus to  → [Safety] → [Reset Password].
- 2 Press **P**  → **P**  → **P**  → **P**  on the remote control. The master password input window will appear.
- 3 Enter the numbers "0313" in the master password input window, then press [Enter]. The password will be reset.

[Accessibility]

[Pointer Options]

 (Q. Settings) →  → [Accessibility] → [Pointer Options]

You can set the pointer speed and shape you want while it is on the screen.

[Menu Transparency]

 (Q. Settings) →  → [Accessibility] → [Menu Transparency]

By setting this feature to [On], you can make some of the menus (e.g. Live Menu, Search, Screen Remote, etc.) transparent.

[High Contrast]

 (Q. Settings) →  → [Accessibility] → [High Contrast]

When this feature is set to [On], it adjusts the background of some of the menus on the screen and font colours to highlight the contrast between the light and dark areas.

- The effect will disappear temporarily when you configure the [Picture Mode] or [Aspect Ratio] settings.

TO UPDATE SOFTWARE

Uses software update to check and obtain the latest version.



 (Q. Settings) →  → [General] → [About This Projector]

Menu	Description
[CHECK FOR UPDATES]	<p>When checking for the latest update version, you can perform updates only if an update file of a later version is available.</p> <p>The projector automatically checks your software version but, if necessary, you can perform a manual check.</p>
[Allow Automatic Updates]	<p>If [Allow Automatic Updates] is selected, when an update is available, the update automatically starts without prompting a question.</p> <p>If [Allow Automatic Updates] is not selected, when an update is available, the update will start after prompting a question.</p>

- The configurable items differ depending upon country.
- The latest version can be obtained via internet connections.
- If software is not updated, certain functions may not work properly.

TROUBLESHOOTING

If you experience any of the problems below while using the product, please check the following. There may be no problem with the product.

Information on customer service for product problems is available in  (Q. **Settings**) →  → [General] → [About This Projector] on the projector.

Abnormal Operation

The screen does not appear for some time after power-on.

- This is because there is a noise-removal process to eliminate any possible noise that may appear during power-on. This does not mean the product is defective.

The pointer of Magic Remote is not appear in the screen.



(Depending on country)

- Your Magic Remote may have run out of batteries.
Replace the batteries and register your Magic Remote again following the instructions shown in MAGIC REMOTE CONTROL of Owner's Manual.
- This only applies to models that support the Magic Remote.

I cannot turn on the Projector.

- Please make sure your projector power plug is correctly connected to the outlet.
- If you are using a multi-outlet, check if it is working properly.
- Try to power on using the button on your projector set.



It says there is no signal on the screen.

- Make sure that the HDMI cable is correctly connected to your projector.
- Go to  →  to choose the connected input.
- Check if your external device, such as set-top box or Blu-ray player, is turned on.

It does not work when I connect a USB device.

- Check that the USB and USB cable versions are 2.0 or higher.

Screen Problems

First of all, perform a  (**Q. Settings**) →  → [Picture] → [Picture Test] for check any abnormalities in the projector.



If you are using a set-top box, turn it off, and then turn it back on.

Make sure that the set-top box is correctly connected to your projector.

The screen shakes after the momentary appearance of vertical/horizontal lines and net pattern.

- Stop using items such as wireless telephones, hairdryers, electrical drills etc. The problem is caused by high-frequency electronic devices such as another projector or strong electromagnetic sources.

I see vertical lines in all four directions on the screen, or colours are blurred when I try to connect to HDMI.

-  (**Q. Settings**) →  → [Picture] → [Aspect Ratio Settings] → [Just Scan] Set [Just Scan] to [Off].
[Just Scan] shows you the original image as it is. You may see noise in all four directions on the screen if the signal contains noise.

The screen is blank or the image is blurred when an HDMI cable is used.

- Check that the HDMI® cable meets the required standards. If it is not a certified HDMI® cable, the screen may flicker or may not display anything.
- Check that the cable is properly connected. Improper connection may cause screen flicker.



Sound Problems

First of all, perform a  (**Q. Settings**) →  → [Sound] → [Sound Test] to check for any abnormalities in the projector.

If you are using a set-top box, turn it off, and then turn it back on.

Make sure that the set-top box is correctly connected to your projector.

The screen is fine, but it does not play any sound.

-  (**Q. Settings**) →  → [Sound] → [Sound Out]
Check whether the [Sound Out] is set to [Internal Projector Speaker + Optical] or [Internal Projector Speaker].

If you use a set-top box, there will be no sound if you have set the volume of the set-top box or your projector to 0 or enabled Mute. Set the volume to an appropriate level.

The sound does not play when I connect to the HDMI/USB port.

- Check that you are using a high-speed HDMI® cable.
- Check that the USB and USB cable versions are 2.0 or higher.
- Use a normal music file (*.mp3, *.wav, *.ogg, *.wma).

PC Connection Problems

The screen remains blank after it is connected to a PC.

- Check that the PC is properly connected to the projector.
- Turn the projector off and back on using the remote control.
- Restart the PC with the projector on.
- Check that the current screen resolution supports the PC input.
- To use dual monitors, check that the PC or notebook supports dual-monitor mode.
- Reconnect the high speed HDMI cable.
- When the RGB output port of the PC is connected to the HDMI input port of the projector, use RGB-to-HDMI gender.
You will not see anything on the screen if you use an HDMI to RGB gender.

The sound does not play when the PC is connected with an HDMI cable.

- Contact your video card manufacturer to check the HDMI audio output. (Video cards designed for use with DVI format files need to be connected separately with an audio cable.)

The screen is cut off or moved to one side after it is connected to a PC.

- Set to a resolution that supports the PC input. (Reboot your PC after changing the resolution.)

[Photo & Video] Movie Playback Problems

For more information about supported files, see “PLAY OTHER DEVICE FILES”.

I cannot find a file in the [Photo & Video].

- Check that the files on the USB storage device can be read by a PC.
- Check that the file extension is supported.



I get a message saying “This file is not supported” or the sound is playing normally but the video is not.

- Check that the file plays without any problems on a PC’s video player. Also check for file damage.
- Check that the file extension is supported.
- Check that the resolution is supported.
- Check that the video codec is supported.
- Check that the frame rate is supported.

I get a message saying “This audio is not supported” or the video is playing normally but the audio is not.





- Check that the file plays without any problems on a PC’s video player. Also check for file damage.
- Check that the file extension is supported.
- Check that the audio codec is supported.
- Check that the bit rate is supported.
- Check that the sample rate is supported.
- Check that the audio channel separation is supported.

I cannot see the subtitles.

- Check that the file plays without any problems on a PC's video player. Also check for file damage.
- Check that the video and subtitle files have the same name.
- Also check that both the video file and the subtitle file are in the same folder.
- Check that the subtitle file format is supported.
- Check that the language is supported. (You can check the language of the subtitle file by opening the file in the Notepad.)
- If subtitles encoding is incorrectly set, subtitles may not be displayed properly. Select  →  in the control panel at the bottom of the video playback screen and change the [CODE PAGE] value.
- If you play a video file stored on another device by using the content sharing feature, subtitles may not be available depending on the program you use.

Network Connection Problems

You can check the network connection status as shown below.

-  (Q. Settings) →  → [Network] → [Wired Connection (Ethernet)]
-  (Q. Settings) →  → [Network] → [Wi-Fi Connection] → [Advanced Wi-Fi Settings]



When X appears next to projector

- Check the projector or the AP (Router).
- Check the connection status of the projector, AP (Router) and Cable Modem.
- Power off and power on in the following order;
 1. The Cable Modem, wait for the Cable Modem to reset.
 2. The AP (Router), wait for the AP (Router) to reset.
 3. The projector.
- If you are using a wireless connection, change the SSID (Network name) and wireless channel of AP (Router).
- If you are using a static IP, enter the IP directly.
- Contact internet service provider or AP (Router) companies.



When X appears next to Gateway

- Check the AP (Router) or consult your Internet service provider.
- Unplug the power cord of the AP (Router), Cable Modem, wait 10 seconds. Reapply power.
- Initialize (Reset) on the AP (Router) or Cable Modem.
- Contact internet service provider or AP (Router) companies.
- Check the AP (Router) manufacturer's website to make sure your router has the latest firmware version installed.



When X appears next to DNS

- Check the AP (Router) or consult your Internet service provider.
- Unplug the power cord of the Cable Modem or the AP (Router), wait 10 seconds. Reapply power.
- After the Cable Modem or AP (Router) has Initialized (Reset), try to reconnect.
- Check that the MAC address of the projector/AP (Router) is registered with your Internet service provider. (The MAC address displayed on the pane of the network status window should be registered with your Internet service provider.)

LG Account Problems

In some countries, access to the website (www.lgappstv.com) may be restricted.

I have already signed up on the projector. Do I still have to sign up again at the website (www.lgappstv.com)?

- If you have already signed up on your projector, you do not have to sign up again on the website. You can sign into the website by using the same ID and password and entering the additional information to complete the email verification process.

Is it possible for the family members to use different IDs on the same projector?



- You can register multiple IDs per projector.

I forgot my ID/Password. What should I do?

- You can initialize the password through E-mail when you select FORGOT PASSWORD? on the sign in screen.
- If you signed up on a PC, you can find your ID/Password on the website (www.lgappstv.com).

Contents Problems

I cannot see any content in HOME.

- This feature is available in certain countries only.
You may not be able to see the content if the service country setting has been changed. Change to the service country you are going to use the service from in  (Q. Settings) →  → [General] → [Location] → [LG Services Country].
- You may not be able to view content that has been deleted. Please reinstall the appropriate app.
- The type of supported content differs by country.
- The content offerings are subject to change or interruption by the service provider.

Internet Browser Problems

Some parts of a particular website are not visible when I am using the Internet.

- The [Web Browser] supports only HTML5 media and not Flash Plug-in.
- The [Web Browser] does not support plug-in installation.
- On the [Web Browser], it may not be possible to play media files in formats other than JPEG/PNG/GIF
- You cannot save attachments or images.

The Internet browser automatically shuts down when I visit a website.

- The Internet browser may be forced to shut down if the available memory size is not sufficient to accommodate the image information for a website.

